

# Flank wear modeling of a tungsten carbide tip using the GMDH method in turning operation

D. Kara Ali\*, M.E.A. Ghernaout\*, S. Galiz\*\*, A. Liazid\*\*

\*Mechanical Engineering Department, Abou Bakr Belkaid University; B.O. 119; Route de Chetouane; 13000-Tlemcen-Algeri, E-mail: dj\_kara\_ali@yahoo.fr

\*\*LTE-Laboratory; ENSET-Oran; B.O. 1523; El'Mnaouer 31000-Oran-Algeria, E-mail: ab\_liazid@hotmail.com

crossref <http://dx.doi.org/10.5755/j01.mech.18.5.2696>

## 1. Introduction

Although machining or material removal with cutting tool processes is an oldest technique of manufacturing machine components, many experimental research works have been performed in this field during the last century. It was the improving tool life and machined surface quality, machine energy consumption, dynamic phenomena, etc...

As a result, any further improvement of the machine, tool and process design must be justified through a series of experimental studies. However, any machining test includes a great number of independent variables and the traditional techniques of the Design of Experiments (DOE), becomes expensive and time consuming. Moreover, uncertainty of many included variables might affect the test outcome in metal cutting testing. To overcome these drawbacks discussed by Astakhov and Galitsky [1] concerning the traditional DOE, this paper uses the powerful method called Group Method of Data Handling (GMDH) as a process modeling tool for forming a statistical model of a complex multi-variables systems using a few process data. This method is introduced by the Ukrainian cyberneticist and engineer A.G. Ivakhnenko [2] for solving modeling and classification problems using the polynomial theory of complex systems. The Ivakhnenko authors [3] have published a review of problems solvable by algorithms of the GMDH. The objectiveness of GMDH algorithm and its satisfactory performance as a non-linear modeling approach has driven a number of researchers to investigate it further as well as test it in a broad spectrum of applications as data mining and knowledge discovery, forecasting and systems modeling, optimization and pattern recognition. The application of the GMDH method to manufacturing starts at the early of 1980s and different versions are considered: basic, modified and enhanced GMDH-type network. Several research works have been performed to build a mathematical model describing tool wear or tool life in the cutting process. Briefly, we indicate as a sample the following works performed since 1980 and found in the literature. Hence, Nagasaka and Hashimoto [4] have estimated the quality of chip disposal and Yoshida and al. [5] have identified the grinding wheel wear of the abrasive cut-off. The work published by Nagasaka and al. [6] has determined an optimum of combination of operating parameters in abrasive cut-off. The prediction and detection of the cutting tool failure has concerned the work performed by Uematsu and Mohri [7]. Jiaa and Dornfeld [8] have published a work concerning the prediction and detection of tool wear. El-Khabeery and El-Axir [9] have

studied the effects of milling roller-burnishing parameters on surface integrity. The work performed by Astakhov and Galitsky [1] deals with the test of the tool life in gundrilling and finally the work presented by Onwubolo and al. [10] concerns the modeling of tool wear in end-milling. Inductive GMDH algorithms are used because they provide a possibility to find automatically interrelations in data, to select the 'optimal' structure of model and to increase the accuracy of existing algorithms. This original self-organizing approach is substantially different from deductive methods commonly used in traditional DOE. This paper describes the use of the GMDH method to build a model for predicting the tool flank wear in a turning operation without lubrication. The aim is to analyze the influence of input variables on the tool life and serving promoting automation of cutting process.

## 2. Background on GMDH method

The GMDH method gives a procedure for modeling complex nonlinear systems from input and output data, based on the principle of heuristic self-organization. This method allows the discovery of the complex relationship between input and output variables objectively without having detail knowledge of the system investigated and a large number of data.

Suppose that the system equation for input variables  $x_i$  and output  $y$  is  $y = f(x_1, x_2, \dots, x_n)$ , where  $y$  denotes the complete description of the system. This function can be expressed by the Volterra series, discrete analogue of which is the Kolmogorov-Gabor polynomial

$$y = b_0 + \sum_{i=1}^m b_i x_i + \sum_{i=1}^m \sum_{j=1}^m b_{ij} x_i x_j + \sum_{i=1}^m \sum_{j=1}^m \sum_{k=1}^m b_{ijk} x_i x_j x_k \quad (1)$$

where  $X(x_1, x_2, \dots, x_m)$  is the input variables vector,  $m$  is the number of input variables,  $B(b_1, b_2, \dots, b_m)$  is the vector of coefficients. Each coefficient in Eq. (1) may be estimated to identify the system. The number of coefficients to be estimated, however, rapidly increases as the system increases in complexity and therefore the calculation will be difficult, with a large number of inputs and outputs data required. The GMDH is an identification technique which has been developed for such solution and which successively approximates the model to the complete description, using partial descriptions. Regression equations obtained by stepwise regression procedure are used as the partial descriptions, while in the basic GMDH; the following second order polynomial is used.

$$\left. \begin{aligned} y_k &= \beta_0 + \beta_1 x_i + \beta_2 x_j + \beta_3 x_i^2 + \beta_4 x_j^2 + \beta_5 x_i x_j \\ k &= 1, 2, \dots, N; \quad i = 1, 2, \dots, m; \quad j = 1, 2, \dots, m-1; \\ N &= m(m-1)/2 \end{aligned} \right\} \quad (2)$$

where  $y_k$  denotes the intermediate variable,  $x_i$  and  $x_j$  are input variables. Hence, this method builds a multilayered perception-type network for obtaining a polynomial description of stochastic system, Fig. 1. The GMDH algorithm proceeds as follow: Step (1); Select the input variables considered to affect the output. Then convert the raw input and output into normalized deviations from the average values. Step (2); Separate the data into a training set and a checking set. The training data are used to estimate the coefficients of the partial descriptions and the checking data are used to evaluate the accuracy of the partial descriptions and to prevent over fitting. Step (3); Form the partial descriptions using the stepwise regression procedure with all inputs taken two at a time. All combinations of  $r$  input variables are generated before learning each layer. The number of combinations is

$${}^m C_r = \frac{m!}{r!(m-r)!} \quad (3)$$

where  $m$  is the number of input variables and  $r$  is the number of inputs for each node (usually set to two according to the basic model introduced by Ivakhnenko [11]. Step (4); calculate the error criterion between each intermediate variable and checking data. By applying an error criterion at each layer, those variables which are least useful for predicting the correct output are filtered out. Step (3) and Step (4) are repeated until the lowest overall error criterion value (based on checking data set) at a certain layer is obtained. When one or more sets of new input and output data are given and it becomes necessary to renew the model to the new data, it can be possible to derive from the work performed by Uemasu and Mohri [7] an algorithm which avoids to forming a new model by means of GMDH, but from the original structure of the obtained model only its coefficients are adjusted with given appropriate weights to the newly given process data. This algorithm is called modified GMDH. This approach was proven to be computationally effective and memory economical and suitable for the situation where the system only changes gradually as in progressive tool wear. The scheme of building up a generation of high order variables is shown in Fig. 2.

2.1. Construction of training and checking set

The objectiveness of GMDH algorithm is based on the utilization of an external criterion to select the optimal model, which requires the data partition. The requirement of splitting data into two groups will lead to different models for different subsamples and researchers have investigated a number of techniques to overcome this situation as reported by Anastasakis and Mort [12]. The most used technique in the machining field is to separate the data points into training set and checking set according to the criterion of variance defined by the Eq. (4), where the variance of each data point,  $D(k)$ , is calculated as

$$D(k) = \left[ \frac{y_j - \bar{y}_j}{\bar{y}_j} \right]^2; \quad j = 1, 2, \dots, p; \quad k = 1, 2, \dots, N \quad (4)$$

where  $p$  represents the range of data.

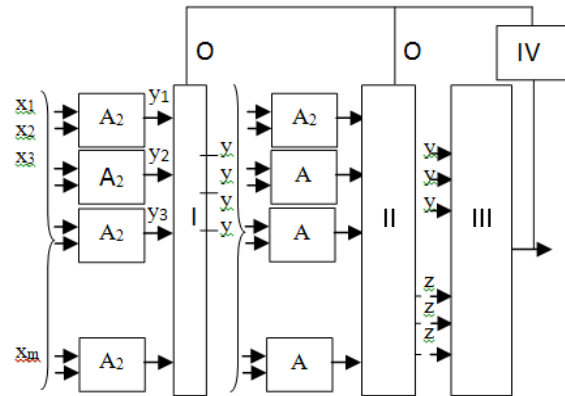

Fig. 1 Multilayered network structure of GMDH. Algorithm of group method of data handling (GMDH) I-first threshold self-selection; II-second threshold self-selection; III-selection from all solutions; IV-threshold optimization

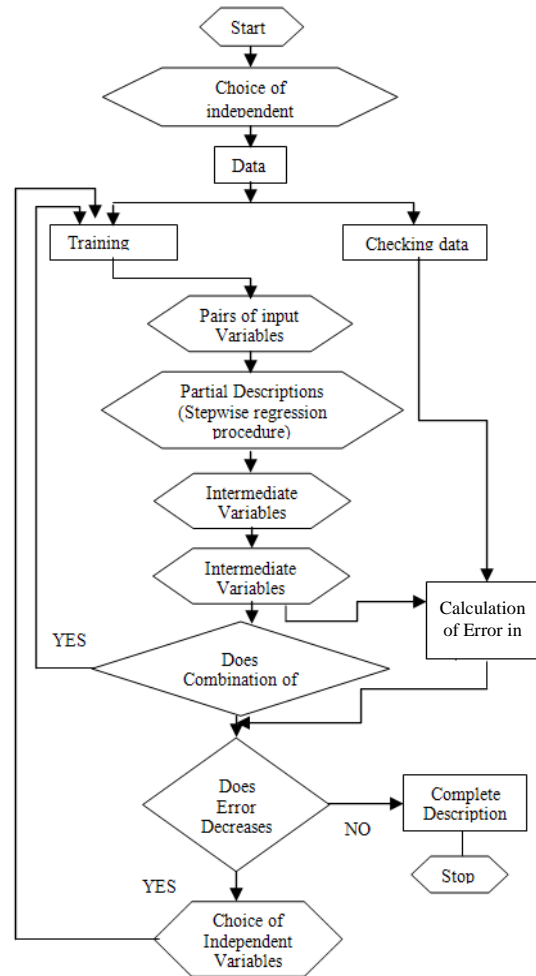

Fig. 2 A flow diagram for modified GMDH method

The points with the larger variance are put into training set and the others into the checking set. The data into the training and checking set are separated using a table of random numbers.

## 2.2. Selection of effective variables

There are different criteria for screening out the least effective variables at each layer such as the regularity criterion, the unbiased criterion, the combined criterion and PRESS criterion [12]. These criteria usually take the common form containing two parts, a cost function which penalize the addition term in each layer, and another representing the mean squared error from regression. Any variable satisfying the criterion enters the next layer automatically. The criterion is evaluated using the checking set. This stage makes the number of retained variables at the output decrease from layer to layer thus the GMDH procedure doesn't become unstable as the process continues.

## 3. Tool flank wear modeling

### 3.1. Experimental setup

A series of experiments were carried out during machining of 80 mm diameter C20 steel bars on a machine tool installed on an appropriate elastic foundation designed to absorb vibrations produced by dynamical forces generated during the cutting process. The flank wear process of a triangular tungsten carbide WNMG tip with 5° rake angle is dealt with. Fig. 3 shows a part of the experimental setup. To measure the flank wear  $VB$ , the procedure implementation is based on using a Nikon profile projector. It is an optical device that allows accurate observation of the surface and the contour of opaque parts. The magnified image is projected onto the screen with perfect amplification. The measurement method is based on the use of cross-line screen. Fig. 4 illustrates the principle of the measurement technique of the tool flank wear  $VB$ . Details of the experiments for measurement of the tool flank wear have been given by Kara and al. in the reference [13].



Fig. 3 Experimental setup part

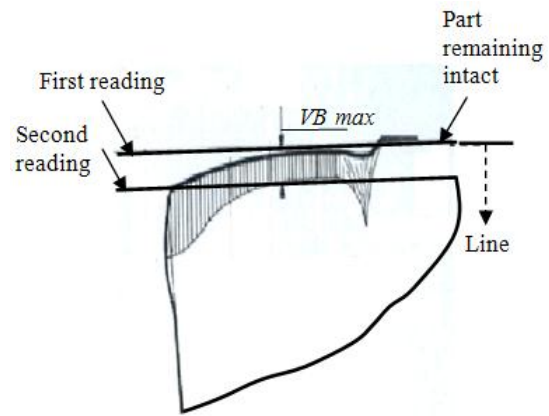

Fig. 4 Measure of the tool wear  $VB$

### 3.2. Design of experiment

The cutting process in turning operation depends on many system parameters whose complex interactions make it difficult to describe the system mathematically. From literature of machining processes it can be deduced easily that the cutting regime variables (speed, feed and depth of cut), the chemical and mechanical properties of the tool, the geometric parameters of the tool, the lubrication quality, the system dynamics, etc..., can be considered candidates as input variables to the causality relationship. Tool flank wear and work-piece surface quality can be considered as the output parameters.

In this paper only the machining parameters were set during experimentation to examine the cutting regime influence on the tool flank wear. This data set constituted the input to the self-organizing network and consisted of three inputs and one output. The first independent input is the cutting speed ( $V$ ). In this study five values in the range from 64 m/min to 237 m/min are considered. The second parameter is the feed ( $f$ ). Five feeds are adopted in this study, ranging from 0.08 mm/rev to 0.2 mm/rev. The third parameter is the depth-of-cut ( $d$ ) and five values are ranging between 0.5 mm to 1.5 mm. The cutting conditions used in this work are summarized in Table 1. Each parameter had five levels selected from practice. Evidently, the influence of system vibrations during cutting process on the obtained experimental results is minimized with special care taken experimentally to avoid this influence. Also, no lubrication was used.

### 3.3. Experimental results and discussions

A three-factor, five-level central composite rotatable design was used in this study. Table 2 shows the arrangement and the results of the twenty experiments carried out in this investigation. The range of each parameter was coded in five levels selected as follows

$$[-1.5 \quad -1 \quad 0 \quad +1 \quad +1.5]$$

The targets for the tool wear are given in the last column of the Table 2. The tool flank wear data were carried out at the same cutting length for each trial cutting. The output of the GMDH reported in this paper is used to develop the mathematical model of the tool flank wear in next section. At least three tests at the each point of the design matrix were carried out.

Summary of cutting conditions

Parameters	Symbol	Levels in code form				
		-1.5	-1	0	+1	+1.5
Cutting speed, m/min	$x_1$	64	89	125	173	237
Feed, mm/rev	$x_2$	0.08	0.10	0.128	0.150	0.200
Depth, mm	$x_3$	0.5	0.75	1	1.25	1.50
Turning operation condition	No lubrication					

Table 2

Experimental results

	Speed $V$ , m/min		Feed $f$ , mm/rev		Depth $d$ , mm		Measured flank wear $VB$ , $\mu\text{m}$
	Actual	Coded	Actual	Coded	Actual	Coded	
1	89	-1	0.1	-1	0.75	-1	18
2	173	+1	0.1	-1	0.75	-1	126
3	89	-1	0.1	-1	1.25	+1	28
4	173	+1	0.1	-1	1.25	+1	152
5	89	-1	0.15	+1	0.75	-1	21
6	173	+1	0.15	+1	0.75	-1	135
7	89	-1	0.15	+1	1.25	+1	32
8	173	+1	0.15	+1	1.25	+1	160
9	64	-1.5	0.128	0	1	0	9
10	237	+1.5	0.128	0	1	0	309
11	125	0	0.128	0	0.5	-1.5	45
12	125	0	0.128	0	1.5	+1.5	80
13	125	0	0.08	-1.5	0.5	0	40.5
14	125	0	0.2	+1.5	0.5	0	50
15	125	0	0.128	0	0.5	0	47
16	125	0	0.128	0	0.5	0	45
17	125	0	0.128	0	0.5	0	46.5
18	125	0	0.128	0	0.5	0	46
19	125	0	0.128	0	0.5	0	48
20	125	0	0.128	0	0.5	0	45.5

#### 4. Mathematical model for the tool flank wear

The model determination was carried out using the simplified algorithm of GMDH. A data sample is divided into two parts. The criterion MSE (Mean Square Error) is used, then approximately two-thirds of tests forms the training subset, and the remaining part of observations (e.g. every third point with the same variance) forms the checking subset. The training subset was used to derive estimates for the coefficients of the polynomial, and the checking subset was used to select the optimal model, that is one for which the regularity criterion MSE assumes its minimum

$$MSE = \frac{1}{N_B} \sum_{i=1}^{N_B} [y_i - \hat{y}_i]^2 \rightarrow \min \quad (5)$$

where  $N_B$  represents the range of checking subset data.

All input and output data in Table 2 are used in the form of the normalized deviations from average values by

$$\xi_i(h) = \frac{x_i(h) - \bar{x}_i}{\bar{x}_i}; \quad \psi_i(h) = \frac{y_i(h) - \bar{y}_i}{\bar{y}_i} \quad (6)$$

where  $i$  ( $i=1,2,3$ ) and  $h$  ( $h=1,2,3,4,5$ ) denote the input variables and the experimental values number respectively. In this study, the algorithm allowed generating a model after three layers in the network. All possible pairs of input or output from previous layer are considered. Based on the outputs of the basic GMDH, the tool flank wear for the turning operation was modeled as

$$y = b_0 + b_1x_1 + b_2x_2 + b_3x_3 + b_4x_1^2 + b_5x_2^2 + b_6x_3^2 + b_7x_1x_2 + b_8x_1x_3 + b_9x_2x_3 \quad (7)$$

where  $x_1, x_2, x_3$  are the normalized speed, feed and depth-of-cut respectively. The GMDH network performed in this work found the ten coefficients {20.247, -0.920, -69.295, -20.513, 0.008, 46.273, 4.320, 1.070, 0.344, and 36.033} leading to the predictive model of the tool flank wear

$$VB = 20.247 - 0.920x_1 - 69.295x_2 - 20.513x_3 + 0.008x_1^2 + 46.273x_2^2 + 4.320x_3^2 + 1.070x_1x_2 + 0.344x_1x_3 + 36.033x_2x_3 \quad (8)$$

The minimal weighted, training and testing-errors at different layers are shown in Table 3. They may be derived from the MSE criterion.

Table 3

Minimal errors at different layers

	Minimal weighted error	Minimal training error	Minimal testing error
Layer1	0.0892427	0.1386601	1.889544
Layer2	0.0563340	0.05288310	0.4065458
Layer3	0.0712320	0.03398841	0.1564479

Fig. 5 shows the performance index on training and testing data for different layers. It could be observed that the error level drops along the network. Fig. 6 shows the GMDH prediction and the corresponding error. The error level clusters are mainly within the range 2.77% to 22.13%. As it could be observed, the prediction values closely follow the experimental results, except for trial number 9 where there is some noticeable deviation.

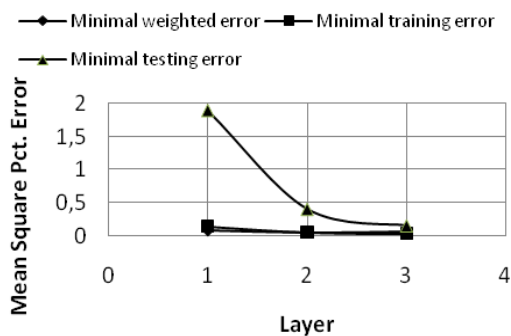

Fig. 5 Performance index on training and testing data for different layers

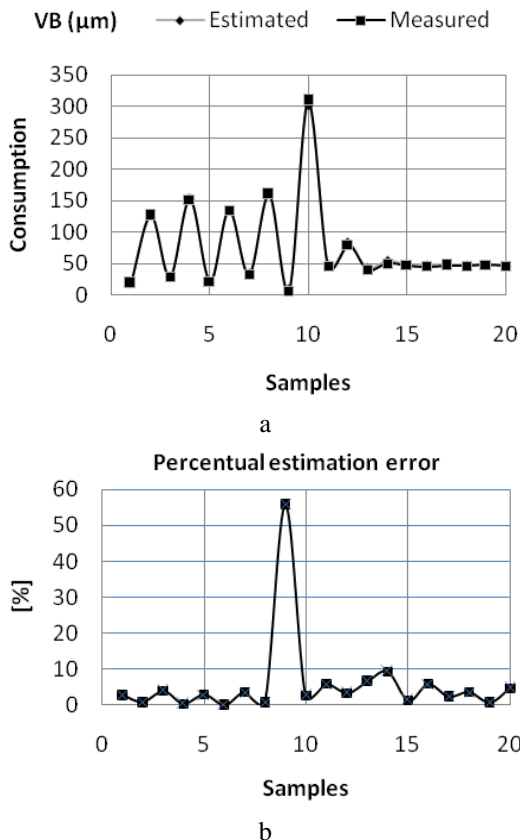

Fig. 6 The GMDH actual and estimated plot and percentage error plot: a) flank wear consumption; b) percentual estimation error

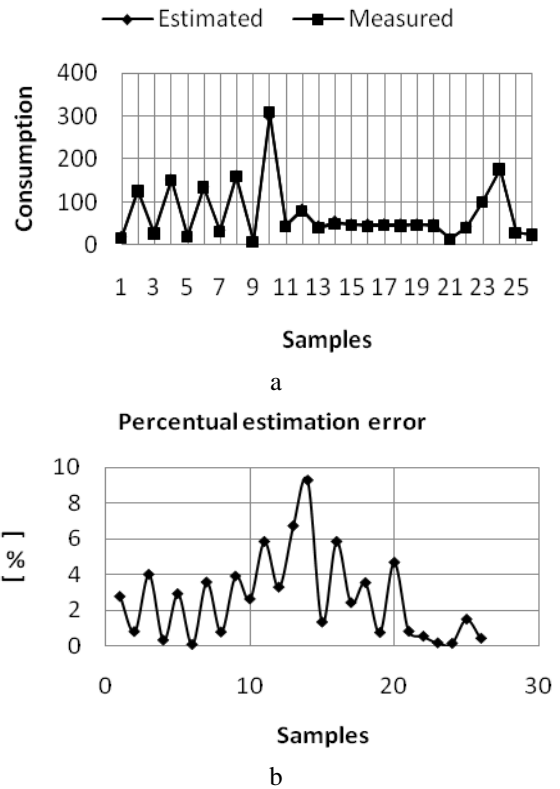

Fig. 7 The modified GMDH actual and estimated plot and percentual estimation error plot: a) flank wear consumption; b) percentual estimation error

The application of the modified GMDH approach with adding a new set of data shown on the Table 4 from line 21 to line 28, provides better results as illustrated by the Fig. 7 where the error level is in a reduced range of 0.1% to 9.27% including trial n°9. The new predictive model with adjusted coefficients is

$$\begin{aligned}
 VB = & 29.247 - 0.920x_1 - 76.304x_2 - 20.461x_3 + \\
 & + 0.007x_1^2 + 45.284x_2^2 + 3.290x_3^2 + \\
 & + 1.125x_1x_2 + 0.354x_1x_3 + 36.230x_2x_3
 \end{aligned} \tag{9}$$

The effect of the speed, feed and depth-of-cut increase on the tool flank wear is clearly shown on the Figs. (8)-(10) where the distribution of tool flank wear according to the input parameters illustrates that when speed, feed and depth-of-cut augment, the tool wear increases. We note the strong influence of speed on the tool flank wear. Figs. (11)-(13) represent the first partial derivatives of the model described by the Eq. (9) according to the speed; feed and depth-of-cut respectively.

All these derivatives increase linearly. Note them as  $S_v = \frac{\partial(VB)}{\partial V}$ ;  $S_f = \frac{\partial(VB)}{\partial f}$ ;  $S_d = \frac{\partial(VB)}{\partial d}$ .

We observe that  $S_v$  does not increase substantially in comparison with  $S_f$  and  $S_d$  in our experimental range conditions. This result reflects the low sensitivity of the wear acceleration according to the cutting speed level. Inversely the  $S_f$  and  $S_d$  are sensitive to the feed and depth-of-cut parameters due to the chip section variation which increases the abrasive wear phenomenon. So, we can conclude that the tool flank wear is strongly affected by the cutting speed parameter but with practically the same wear

process acceleration at each level of the cutting speed. The explanation of this phenomenon can be given by the fact that flank wear is not strongly related to thermal phenomena generated by the increase in cutting speed than the me-

chanical abrasion caused by the chip section (defined by depth-of-cut and feed) on the tool flank even without lubrication.

Table 4

Added set of the new input and output data

Trial $n^\circ$	Speed $V$ , m/min	Feed $f$ , mm/rev	Depth $d$ , mm	Measured wear $VB$ , $\mu\text{m}$	Basic GMDH	Modified GMDH
1	89	0.1	0.75	18	17.500	18.500
2	173	0.1	0.75	126	146.944	127.028
3	89	0.1	1.25	28	28.674	29.124
4	173	0.1	1.25	152	172.566	152.520
5	89	0.15	0.75	21	20.727	21.616
6	173	0.15	0.75	135	154.665	134.869
7	89	0.15	1.25	32	32.801	33.146
8	173	0.15	1.25	160	181.187	161.267
9	64	0.128	1	9	5.224	9.352
10	237	0.128	1	309	345.854	300.857
11	125	0.128	0.5	45	53.884	47.632
12	125	0.128	1.5	80	89.624	82.639
13	125	0.08	0.5	40.5	49.464	43.223
14	125	0.2	0.5	50	60.915	54.637
15	125	0.128	0.5	47	53.884	47.632
16	125	0.128	0.5	45	53.884	47.632
17	125	0.128	0.5	46.5	53.884	47.632
18	125	0.128	0.5	46	53.884	47.632
19	125	0.128	0.5	48	53.884	47.632
20	125	0.128	0.5	45.5	53.884	47.632
21	75	0.1	1	14		13.883
22	100	0.128	1.25	42		42.233
23	150	0.2	0.75	101		100.812
24	200	0.15	0.5	177		177.279
25	75	0.2	1.5	30		30.452
26	75	0.128	1.5	25		24.889
27	100	0.08	1	32		31.559
28	150	0.08	0.75	85		84.936

## 5. Optimizing the tool wear model in turning operation

Several optimization techniques (genetic algorithm, particle swarm optimization, etc,...) could be used to further solve the problem of Eq. (9) subject to the machining constraint given as  $46 \leq x_1 \leq 237$ ;  $0.08 \leq x_2 \leq 0.2$ ;  $0.5 \leq x_3 \leq 1.5$ .

This solution will give the optimal values for the response and input parameters. A number of optimization techniques are available that can easily solve Eq. (9) optimally. Here we apply the recent developed technique VNS (Variable Neighborhood Search).

### 5.1. VNS methodology

The basic idea of VNS metaheuristic is to use more than one neighborhood structure and to proceed to a systematic change of them within a local search.

The algorithm remains in the same solution until another solution better than the incumbent is found and then jumps there.

Neighborhoods are usually ranked in such a way that intensification of the search around the current solution is followed naturally by diversification. The level of

intensification or diversification can be controlled by a few easy to set parameters. We may view the VNS as a 'shaking' process where a movement to a neighborhood further from the current solution corresponds to a harder shake.

Unlike random restart, the VNS allows a controlled increase in the level of the shake. Let us denote by  $Nk$ ;  $k = 1, \dots, K_{Max}$  a finite sequence of preselected neighborhood structures, and by  $Nk(x)$  the set of feasible solutions corresponding to neighborhood structure  $Nk$  at the point  $x$ , where  $x$  is an initial solution. Let us note that most local search metaheuristics use one neighborhood structure; i.e.  $K_{Max} = 1$ . The following algorithm presents steps of the basic VNS heuristic.

Repeat until the stopping criterion is met:

- (1) Set  $k \leftarrow 1$ ;
- (2) Until  $k > K_{Max}$  repeat the following steps:
  - (a) Shaking: generate a point  $x'$  at random from  $Nk(x)$ ;
  - (b) Local search: Apply some local search method with  $x'$  as the initial solution; denote by  $x''$  the so obtained local minimum;
  - (c) Move or not: If  $x''$  is better than the incumbent move there ( $x' \leftarrow x''$ ) and set  $k \leftarrow 1$ ; otherwise  $k \leftarrow k+1$ .

The stopping criterion may be e.g. the predeter-

mined maximal allowed CPU time, the maximal number of iterations, or the maximal number of iterations between two improvements.

Let us note that the point  $x'$  is generated in step (2) at random in order to avoid cycling which might occur if any deterministic rule was used.

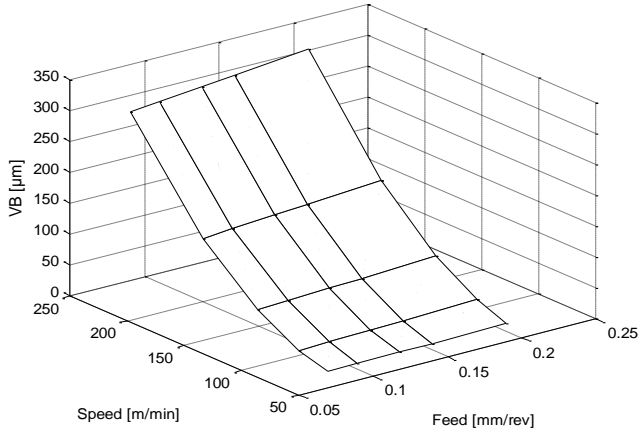

Fig. 8 Tool flank wear according to speed and feed. Depth of cut = 1 mm

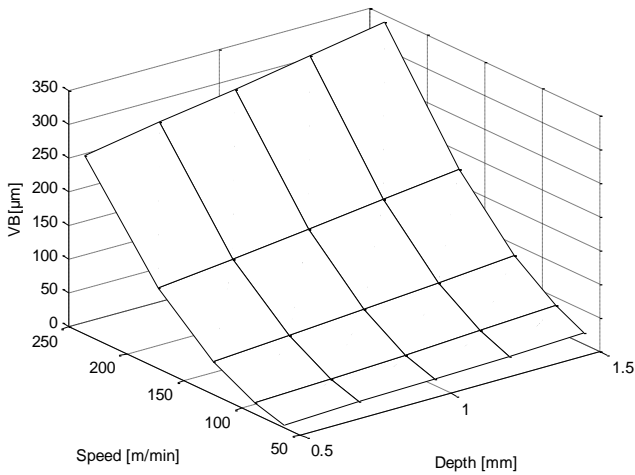

Fig. 9 Tool flank wear according to speed and depth of cut. Feed = 128 mm/rev

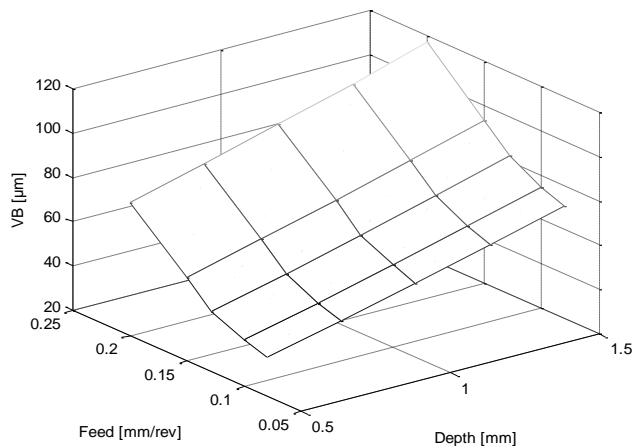

Fig. 10 Tool flank wear according to speed and depth of cut. Cutting speed = 25 m/min

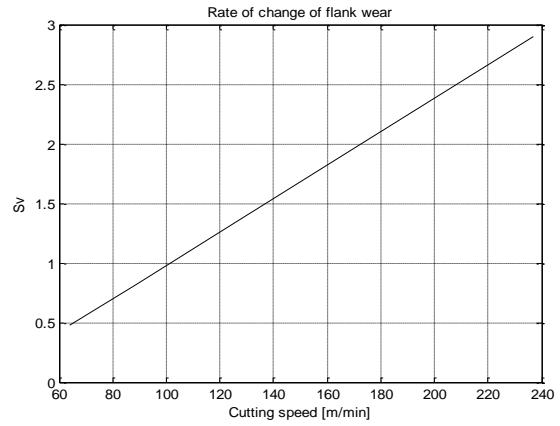

Fig. 11 Rate of change of tool flank wear according to the cutting speed

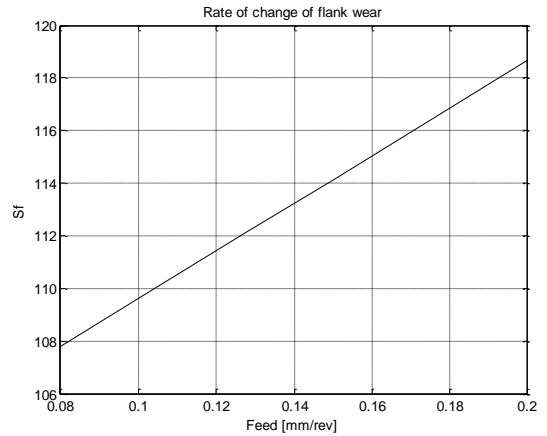

Fig. 12 Rate of change of tool flank wear according to the feed

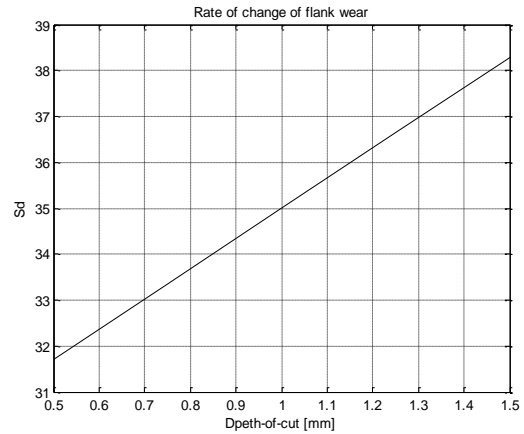

Fig. 13 Rate of change of tool flank wear according to the depth of cut

5.2. Results

For the tool wear, the optimal solution for Eq. (9) is given as shown in Table 5. The optimizer found optimal values of speed  $x_1 = 60$  m/min;  $x_2 = 0.128$  mm/rev;  $x_3 = 1$  mm and  $VB = 9.01$   $\mu$ m. These inputs values are the best ones to achieve the minimum wear possible in our turning range regimes. Using an optimization technique gives the best possible turning conditions and consequently such approach is extremely useful in a realizing a computer-aided process-planning system in a manufacturing environment.

Table 5  
Optimal solution using optimization technique

	Objective function <i>VB</i>	$x_1$	$x_2$	$x_3$
GMDH	9.35	64	0.128	1
VNS	9.01	60	0.128	1

### 5.3. Observations

Observing the experimental results from Tables 3 and 4, it is indicated that the trial No. 9 provides a value of  $VB = 9$  closer to that found using the optimization tool of the model represented by Eq. (9). This experimentation shows that both GMDH and VNS methodology agree in their solutions. However, the GMDH method does not have a property that confirms that it has found a global minimum value. By using VNS methodology, we have confirmed that our GMDH approach can find a global minimum condition. Also, it is interesting to observe that the GMDH method uses only input values used for experimentation but the optimization technique such as VNS can find input values that were not used for the initial experiments. This is one difference between the solution realized using GMDH and other optimization techniques.

### 6. Conclusion

In this study, a GMDH algorithm is performed for modeling flank wear of a tungsten carbide tip as a function of the cutting speed, feed, and depth-of-cut during a turning operation. Firstly, the modeling methodology is presented, and then we perform a predictive model of the problem being solved in the form of a second-order polynomial based on the input variables. A modified GMDH algorithm is then applied to ensure robust results. The retained model seems with a great predictive capacity because the data obtained outside the experimental results have been well predicted. Also, the performed model indicates that cutting speed influences strongly the tool flank wear compared to the feed or the depth-of-cut. Moreover, this approach makes it easy to present the realized solution in a form that could be further optimized for the input parameters; i.e. the best cutting regime. Hence, the recent VNS approach is applied successfully in this work.

### References

1. **Astakhov, V.P.; Galitsky, V.** 2005. Tool life testing in gundrilling: an application of the group method of data handling (GMDH), *Int. J. of machine tools & Manufacture* 45: 509-517. <http://dx.doi.org/10.1016/j.ijmachtools.2004.09.003>.
2. **Ivakhnenko, A.G.** 1968. The group method of data handling - A rival of the method of stochastic approximation, *Soviet Automatic Control c/c of Avtomatika* 13(3): 43-55.
3. **Ivakhnenko, A.G.; Ivakhnenko, G.A.** 1995. The review of problems solvable by algorithms of the group method of data handling (GMDH), *Pattern Recognition and Image Analysis* 5(4): 527-535.
4. **Nagasaka, K.; Hashimoto, F.** 1981. Estimation of quality of chip proposal by GMDH of variable selection type, *Int. J. Mech. Tool Des.* 21(3/4): 271-277.
5. **Yoshida, T.; Nagasaka, K.; Kita, Y.; Hashimoto, F.** 1986. Identification of a grinding wheel wear equation of the abrasive cut-off by the modified GMDH, *Int. J. Mech. Tool Des.* 26(3): 283-292. [http://dx.doi.org/10.1016/0020-7357\(86\)90006-5](http://dx.doi.org/10.1016/0020-7357(86)90006-5).
6. **Nagasaka, K.; Yoshida, T.; Kita, Y.; Hashimoto, F.** 1987. Optimum combination of operating parameters in abrasive cut-off, *Int. J. Mech. Tool Manufact.* 27(2): 167-179. [http://dx.doi.org/10.1016/S0890-6955\(87\)80048-2](http://dx.doi.org/10.1016/S0890-6955(87)80048-2).
7. **Uematsu, T.N.; Mohri, N.** 1986. Prediction and detection of cutting tool failure by modified group of data handling, *Int. J. Mach. Tool Des. Res.* 26(1): 69-80. [http://dx.doi.org/10.1016/0020-7357\(86\)90197-6](http://dx.doi.org/10.1016/0020-7357(86)90197-6).
8. **Jiaa, C.L.; Dornfeld, D.A.** 1998. A self-organizing approach to the prediction and detection of tool wear, *ISA Transactions* 37: 239-255. [http://dx.doi.org/10.1016/S0019-0578\(98\)00035-4](http://dx.doi.org/10.1016/S0019-0578(98)00035-4).
9. **El-Khabeery, M.M.; El-Axir, M.H.** 2001. Experimental techniques for studying the effects of milling roller-burnishing parameters on surface integrity, *Int. J. of machine tools & Manufacture* 41: 1705-1719. [http://dx.doi.org/10.1016/S0890-6955\(01\)00036-0](http://dx.doi.org/10.1016/S0890-6955(01)00036-0).
10. **Onwubolu, G.C.; Buryan, P.; Lemke, F.** 2007. Modeling tool wear in end-milling using enhanced GMDH learning networks, *Int. J. Adv. Manuf. Technol.* 39(11):1080-1092. <http://dx.doi.org/10.1007/s00170-007-1296-1>.
11. **Ivakhnenko, A.G.** 1971. Polynomial theory of complex systems, *IEEE Trans. Syst. Man Cybern., SMC-1*: 364-378.
12. **Anastasakis, L.; Mort, N.** 2001. The development of self-organization techniques in modeling: A review of the group method of data handling (GMDH), Department of Automatic Control & Systems Engineering, University of Sheffield, Research report N° 813. <http://dx.doi.org/10.1109/TSMC.1971.4308320>.
13. **Kara-Ali, D.; Liazid, A.; Cheikh, A.; Hadjoui, F.** 2007. Influence des paramètres de coupe sur l'usure d'une plaquette en carbure métallique, *COST: Revue Technologique et Scientifique* 5: 39-46.



D. Kara Ali, M.E.A. Ghernaout, S. Galiz, A. Liazid

VOLFRAMO KARBIDO PLOKŠTELĖS  
UŽPAKALINIO PAVIRŠIAUS IŠSIDĖVĖJIMO  
TEKINANT MODELIAVIMAS GRUPINIO DUOMENŲ  
APDOROJIMO METODU

Re z i u m ė

Gamyboje įprastais metodais ne visada pavyksta sukurti patikimą įrankio išsidėvėjimo apskaičiavimo matematinį modelį, paremtą apdirbamos medžiagos plastine deformacija. Kartais gaunamos didelės prognozavimo paklaidos, trikdančios pjovimo procesą. Šis straipsnis skirtas užpakalinio paviršiaus išsidėvėjimui tekinimo metu prognozuoti taikant galingą metodą, vadinamą grupiniu duomenų apdorojimo metodu. Kaip proceso modeliavimo įrankis šio metodo algoritmas nustato matematinę ryšį tarp įrankio užpakalinio paviršiaus išsidėvėjimo ir išmatuotųjų veikiančių kintamųjų. Pasiūlytas metodas taikomas kompleksiniam daugelio kintamųjų sistemos statistiniam modeliui formuoti naudojant nedaug proceso duomenų. Įrankio išsidėvėjimo modelis, sudarytas grupinio duomenų apdorojimo metodu, įgalina prognozuoti ypač tiksliai ir parodo naudojamų kintamųjų įtaką pjovimo įrankio ilgaamžiškumui. Specialiai reikia atkreipti dėmesį į tai, kaip išvengti tekinimo proceso dinamikos įtakos eksperimentinių tyrimų duomenims. Pasiūlytas metodas parodė, kad įrankio išsidėvėjimas, o kartu ir ilgaamžiškumas yra kompleksinių pjovimo parametrų: greičio, pastūmos ir pjovimo gylio, funkcija.

D. Kara Ali, M.A. Ghernaout, S. Galiz, A. Liazid

CUTTING TOOL WEAR PREDICTION BY USING  
THE GROUP METHOD OF DATA HANDLING  
(GMDH)

S u m m a r y

In machining area, the use of conventional approach to develop a reliable method predicting tool wear with a mathematical model based on the plastic deformation of the work material cannot always deal to satisfactory results. Sometimes the conventional model gives rather large prediction errors by the disturbance into the cutting process. This paper deals with the prediction of the tool flank wear in a turning operation using the powerful technique called Group Method of data Handling (GMDH). As a process modeling tool, the GMDH algorithm determines a mathematical representation between tool flank wear and the measured variables involved. The GMDH method is said useful for forming a statistical model of a complex multi-variable system using a few process data. The tool wear model obtained by applying GMDH has considerably high prediction accuracy and indicates the influence of input variables on the cutting tool life. Special care was taken to avoid the influence of the dynamic phenomenon of turning process on the obtained experimental data. The derived model reveals that tool wear and consequently tool life is a complex function according to cutting parameters: speed, feed and depth of cut.

**Keywords:** machining; turning process; tool wear; GMDH; mathematical model.

Received April 01, 2011

Accepted October 12, 2012