

# Automatic Classification of Heartbeats Using Wavelet Neural Network

Radhwane Benali · Fethi Berekssi Reguig ·  
Zinedine Hadj Slimane

Received: 23 April 2010 / Accepted: 21 June 2010 / Published online: 13 July 2010  
© Springer Science+Business Media, LLC 2010

**Abstract** The electrocardiogram (ECG) signal is widely employed as one of the most important tools in clinical practice in order to assess the cardiac status of patients. The classification of the ECG into different pathologic disease categories is a complex pattern recognition task. In this paper, we propose a method for ECG heartbeat pattern recognition using wavelet neural network (WNN). To achieve this objective, an algorithm for QRS detection is first implemented, then a WNN Classifier is developed. The experimental results obtained by testing the proposed approach on ECG data from the MIT-BIH arrhythmia database demonstrate the efficiency of such an approach when compared with other methods existing in the literature.

**Keywords** ECG · Feature extraction · QRS · Classification · WNN · Wavelet · Cardiac arrhythmia

## Introduction

The electrocardiogram signal is widely employed as one of the most important tools in clinical practice in order to assess the cardiac status of patients [1]. Automatic heartbeat classification using the electrocardiogram signal (ECG) has

been a field of intensive research during the last years. Some cardiac arrhythmias appear infrequently, and very long ECG recording (Holter) is needed to capture them. Analysis of such large amount of data is very time consuming and, therefore, automatic processing systems can be of great assistance to the clinician.

For this reason, this problem has attracted much concern and numerous methods have been proposed by researchers to recognize ECG automatically. Most of these methods are developed in two steps: feature extraction and pattern classification. The first step which is concerned with ECG features extraction has been performed either in the time domain to obtain morphologic features (such as width, height and area of QRS complex, heart-rate variability etc...) [2, 3], or in the frequency domain in order to find changes in QRS-complex power spectra between normal and arrhythmia waveforms [4, 5], more over in time-frequency domain [6, 7] to exhibit simultaneously ECG time and frequency features ; Spatial transformations [8, 9] has often been used to extract non linear behavior in heart rate variability. The second step: classification has been developed by means of several techniques, such as the Artificial Neural Network (ANN) that can be realized through different architectures such as Kohonen Self Organizing Map (KSOM) [10, 11], MultiLayer Perceptron (MLP) [12, 13], and Probabilistic Neural Network (PNN) [14].

In this paper, we propose an automated method for ECG heartbeats classification. Five different heartbeats are considered: N (Normal), PVC (Premature ventricular contractions), LBBB (Left bundle branch blocks) RBBB (Right bundle branch blocks) and APC (Atrial premature contraction).

For the feature extraction step, we used an algorithm developed, implemented and evaluated within our research laboratory GBM laboratory (Génie Bio-Médical) at Tlemcen

---

R. Benali (✉) · F. Berekssi Reguig · Z. Hadj Slimane  
Biomedical Engineering Laboratory, Department of Electronics,  
Faculty of Engineering Sciences, Abou Bekr Belkaid University,  
Tlemcen, Algeria  
e-mail: benali\_redouane@yahoo.fr

F. Berekssi Reguig  
e-mail: f\_berekssi@mail.univ-tlemcen.dz

Z. Hadj Slimane  
e-mail: hadjslim@yahoo.fr

University [15]. This algorithm is based on the technique introduced by So an Khan [16]. For the classification step, a wavelet neural network (WNN) is developed. This technique combines wavelet transform and neural network [17].

The developed algorithms are implemented and evaluated on MIT-BIH arrhythmia database. The obtained results are compared with other algorithms existing in the literature.

## Method

In this work, the proposed procedure for the automatic recognition of the normal and abnormal ECG beats is illustrated in Fig. 1. It consists on the following steps:

- ECG signals collection
- ECG data pre-Processing.
- ECG Features Extraction.
- ECG classification by Wavelet Neural Network Classifier (WNN).

### ECG signals collection

An ECG signal represents the changes in electrical potential during the heartbeat as recorded with non-invasive electrodes on the limbs and chest. A typical ECG signal (Fig. 2) consists of the P-wave, QRS complex and T-wave.

The P wave represents atrial depolarization, the QRS complex, the ventricular depolarization, and the T wave the ventricular repolarization.

The ECG signals used to evaluate the proposed method are recordings taken from the MIT-BIH arrhythmia database [18]. These ECG signals are sampled at a frequency of 360 Hz. Two or more cardiologists have made the diagnosis for these various records and they have annotated each cardiac cycle. These annotations will be exploited in our proposed method respectively for the learning step of the neural network and for the classification assessment step.

The study is focused on the classification of the five predominant heartbeat classes in the MIT-BIH arrhythmia database. These are illustrated in the Fig. 3 below and represents respectively the:

- > Normal beats (N).
- > Premature ventricular contractions (PVC) type1 and type 2.
- > Left bundle branch blocks (LBBB).

- > Right bundle branch blocks (RBBB).
- > Atrial premature contraction (APC).

### ECG data pre processing

The first step of signal pre processing is filtering the ECG signal because as any other measured signal, ECG is also contaminated with different frequency noises. It is well known that frequency content of the ECG signal is between 0.05 hz and 100 hz as specified in [1], therefore a band pass filter in this frequency range is implemented. This is used to eliminate motion artifact, baseline wander. Also a 50 Hz notch filter is used to eliminate power line interference.

### ECG features extraction

The important step in building an efficient classifier system is the generation of the diagnostic features, in the basis of which the classifier will recognize the pattern.

For the QRS detection, we have used an algorithm developed and implemented in our research laboratory GBM at Tlemcen university by hadj slimane et al. [15], this algorithm is based on the technique introduced by So an Khan [16].

It is carried out in five steps after the bandpass filter

- differentiator
- First-order backward difference
- non linear transform and center-clipping transformation
- moving window integrator

A brief description of these steps is given below.

In fact, the algorithm benefits from the steep slope of the QRS complex for its detection. As a first step the ECG slope is calculated approximately by the Eq. 1. It is shown in Fig. 2.b.

$$\begin{aligned} slope(n) = & -2x(n-2) - x(n-1) + x(n+1) \\ & + 2x(n+2) \end{aligned} \quad (1)$$

where,  $x(n)$  represents the amplitude of ECG data at discrete time  $n$ .

The signal is approximated by the first-order backward difference [Fig. 4(c)]. This transformation is defined by Eq. 2

$$y1(n) = slope(n) - slope(n-1) \quad (2)$$

where  $slope(n)$  is the differentiated signal.

**Fig. 1** Block diagram of the proposed method

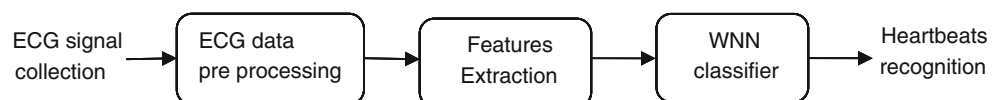

Let  $y_2(n)$  denotes the output from the nonlinear transform (1), i.e.

$$y_2(n) = \begin{cases} |y_1(n)*y_1(n-1)*y_1(n-2)|, & \text{if } y_1(n), y_1(n-1) \text{ et } y_1(n-2) \text{ have the same sign} \\ 0 & \text{otherwise} \end{cases} \quad (3)$$

Then a center-clipping transformation to extract the feature in  $y_2(n)$  (Fig. 4.d) is applied. This transformation is defined by

$$y_3(n) = \begin{cases} 0 & y_2(n) < T_s \\ y_2(n), & y_2(n) > T_s \end{cases} \quad (4)$$

where  $T_s$  is a threshold value. In general it is less than ten percent of the highest peak in the first 2 s signal  $y_3(n)$ . In order to produce a signal that includes information about the slope and the width of the QRS complex, a moving window integrator is used. It is calculated from

$$y_4(n) = \left(\frac{1}{m}\right)(y_3(n - (M - 1)) + y_3(n - (M - 2)) + \dots + y_3(n)) \quad (5)$$

where  $M$  is the number of samples in the width of the integration window.

Figure 4.e illustrates the signal after the moving averaging step and delayed by the total process time of the detection algorithm. The number of samples  $M$  in the moving window is important. Generally, the width of the window should be approximately the same as the widest possible QRS. Following this step, the signal is compared with another threshold value  $T_q$ . In general, it is less than ten percent of the highest peak in the first 2 s signal  $y_4(n)$ . The resulting signal contains only the QRS complex, as given by the following equation

$$QRS(n) = \begin{cases} ECG(n), & y_4(n) > T_q \\ 0, & y_4(n) < T_q \end{cases} \quad (6)$$

where  $y_4(n)$  is the output of the moving average.

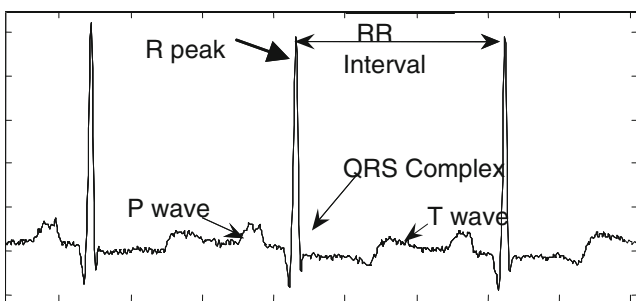

Fig. 2 ECG of a healthy person

Figure 4.f illustrates the result of the QRS complex detection. The benefit of this algorithm lies in its simplicity and its good accuracy to detect QRS complex. The detection performance of the algorithm as stated by Hadj Slimane et al. [15] is over 99.9% when MIT-BIH database was used.

Once the QRS complexes are detected, different parameters are measured. These are considered as ECG features which will be used in the classification step. These features are:

- RRp : the distance between the current R-wave and the previous R-wave.
- RRs : the distance between the current R-wave and the following R-wave.
- RRs / RRp : the ratio between the distance RR following the previous one.
- QRS : the duration of the QRS complex.
- R-Amp : R-wave amplitude

### ECG beats classification using wavelet neural network

#### Presentation of the wavelet neural network

The idea of combining wavelets with neural networks has led to development of adaptive wavelet neural networks (WNN) [19].

The wavelet neural networks (WNN) have recently emerged as a powerful new type of artificial neural networks (ANN). They resemble radial basis function (RBF) networks because of the localized support of their wavelet basis functions.

In contrast to classical sigmoidal-based ANNs, wavelet networks provide efficient network construction techniques, faster training times, and multiresolution analysis capabilities [17].

Wavelet neural networks (WNNs) were first proposed as an alternative to classical feedforward ANNs for approximating nonlinear functions [17]. WNNs are feedforward neural networks with one hidden layer, comprised normally of wavelets as activation functions, and a linear output layer. The output layer of the WNN represents the weighted sum of the hidden layer units.

The structure of the wavelet neural network proposed in this paper to identify the ECG beats is illustrated in Fig. 5. With:  $net_j = \sum_{k=1}^N w_{jk} \cdot x_k, j = 1, 2, \dots, L$

**Fig. 3** Typical cardiac arrhythmias in time domain: **a** Normal beat, **b** premature ventricular contraction type 1, **c** premature ventricular contraction type 2, **d** Atrial premature beat, **e** right bundle branch block beat and **f** left bundle branch block beat

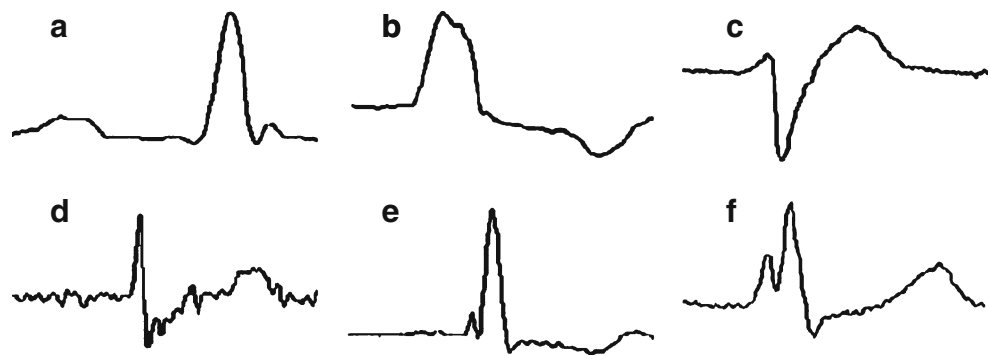

The wavelet neural network structure model is given by

$$\hat{y}(t) = \sum_{j=1}^L w_j \Psi \left( \frac{\sum_{n=1}^N w_{jn} x(t) - b_{1j}}{a_j} \right) - b_2 \quad (7)$$

Where

- $\Psi(t)$  is the wavelet transfer function
- $w_{jn}$  is the connection weight between the  $j^{\text{th}}$  hidden neuron with the  $n^{\text{th}}$  input neuron
- $w_j$  is the connection weight between the  $j^{\text{th}}$  hidden neuron with the output neuron
- $b_{1j}$  is the translate parameter of the wavelet transform
- $a_j$  is the scale parameter of the wavelet transform

- $b_2$  is the bias parameter in the output neurons
- $L$  is the number of hidden neurons
- $N$  is the number of input neurons

Constructing the wavelet network model needs to select wavelet functions as less as possible from mother function set. These are excitation function for the network node, and need to do parameter estimation.

#### Wavelet neural network training algorithm

Besides the connection weight  $w_{jn}$  between the hidden layer with the input layer and the connection weight  $w_j$  between the output layers with the hidden layer, the scale

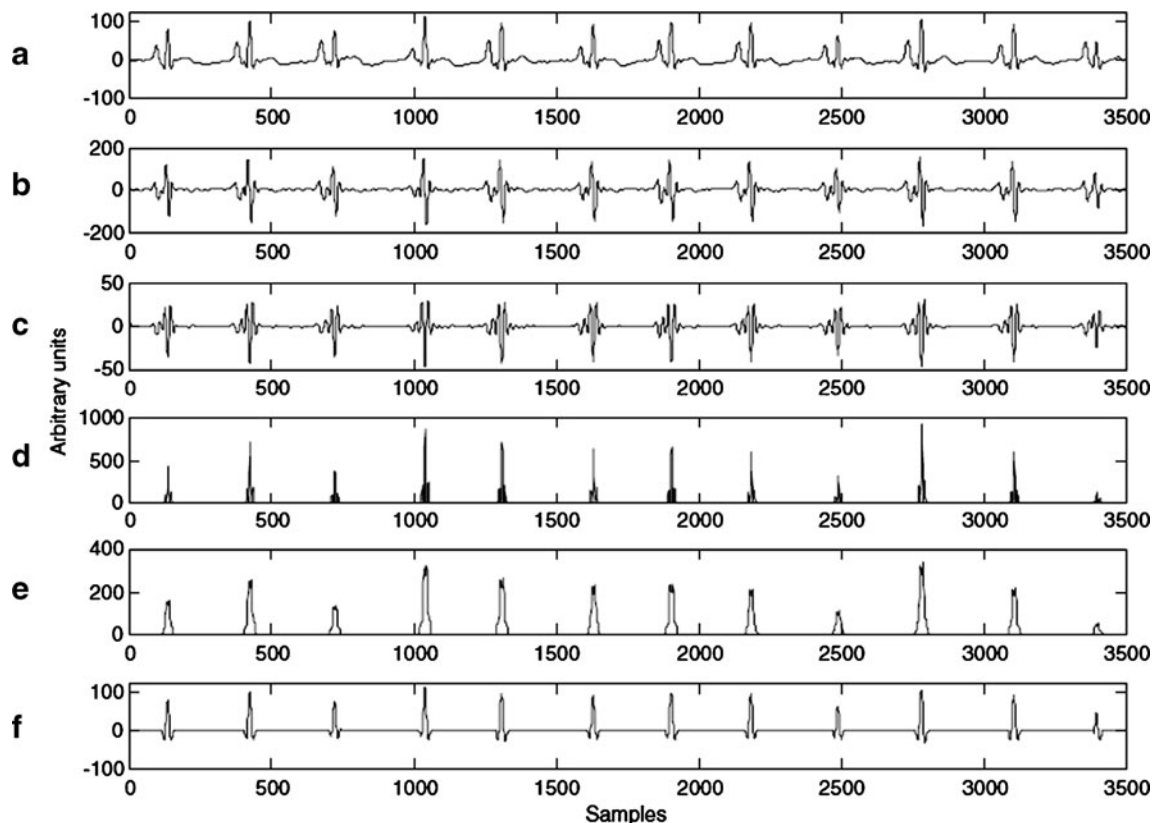

**Fig. 4** QRS detection algorithm processing steps. **a** Output of bandpass filter. **b** Output of differentiator. **c** First-order backward difference. **d** The output from the nonlinear transform and center-clipping transformation. **e** Results of the moving window integrator. **f** Results of the QRS complex detection

**Fig. 5** Wavelet neural network structure (WNN)

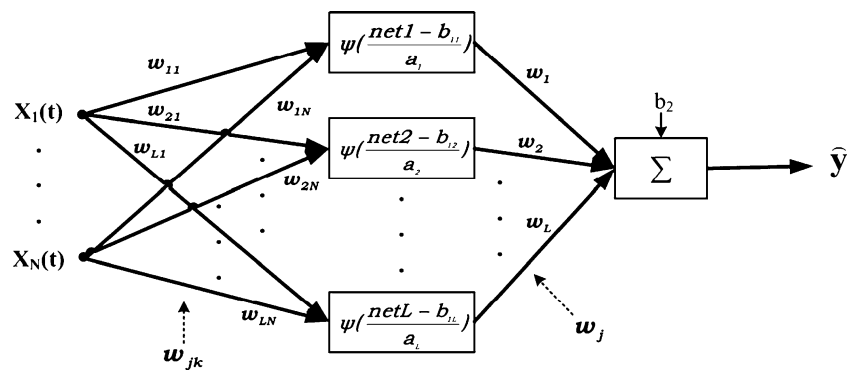

parameters  $a_j$  and the translation parameters  $b_{1j}$  in the adapted WNNs can be adjusted by the corresponding learning algorithm.

The convergence of the algorithm is achieved by minimizing the root mean square error (RSME) energy [17] (known also as the cost function  $E$  and given by Eqs. 8 & 9) between the estimated value  $\hat{y}(t)$  and the real value  $y(t)$ .

The minimization of the cost function  $E$  is achieved through the optimization of the network parameters  $w_{jn}$ ,  $w_j$ ,  $a_j$  and  $b_{1j}$ .

$$E = \frac{1}{2} \sum_{t=1}^D [y(t) - \hat{y}(t)]^2 \tag{8}$$

$$E = \frac{1}{2} \sum_{t=1}^D [e(t)]^2 \tag{9}$$

Where  $D$  is the number of training samples,

$\hat{y}(t)$  is the estimated output which is calculated by model in of training samples  $t$ , and  $y(t)$  is the real value of training samples  $t$ .

A learning algorithm modifies the wavelet network parameters, that is, the scale and translation coefficients of every wavelet neuron, as well as the weights of the linear combination (network input and network output).

The minimization is performed by iterative gradient-based methods.

**Table 1** MIT-BIH arrhythmia database records included in our dataset

Heart beats	Records	Patient, Age	Nbr. of beats	Total number of beats
Normal (N)	MIT-119	Female, 51	1543	8860
	MIT-200	Male, 64	1743	
	MIT-209	Male, 62	2620	
	MIT-212	Female, 32	923	
	MIT-221	Male, 83	2031	
Premature ventricular contraction (PVC)	MIT-119	Female, 51	444	2750
	MIT-200	Male, 64	823	
	MIT-214	Male, 53	256	
	MIT-221	Male, 83	396	
	MIT-233	Male, 57	831	
Left Bundle Branch block (LBBB)	MIT-109	Female, 64	2492	6610
	MIT-111	Female, 47	2115	
	MIT-214	Male, 53	2003	
Right Bundle Branch block (RBBB)	MIT-118	Male, 69	2163	7170
	MIT-124	Male, 77	1531	
	MIT-212	Female, 32	1825	
	MIT-231	Female, 72	1254	
	MIT-232	Female, 76	397	
Atrial Premature Contraction (APC)	MIT-118	Male, 69	96	1890
	MIT-200	Male, 64	30	
	MIT-209	Male, 62	383	
	MIT-232	Female, 76	1381	

**Table 2** Distribution of the ECG beats in Training and Testing Dataset

Heart beats	Training dataset (50%)	Testing Dataset (50%)
N	4430	4430
PVC	1375	1375
LBBB	3305	3305
RBBB	3585	3585
APC	945	945
Total	13640	13640

The partial derivative of the cost function with respect to network's parameters ( $w_{jn}$ ,  $w_j$ ,  $a_j$ , and  $b_{lj}$ ) are:

$$\frac{\partial E}{\partial w_j} = - \sum_{i=1}^D e(t) \cdot \Psi(\tau) \quad (10)$$

$$\frac{\partial E}{\partial w_{jn}} = - \sum_{i=1}^D e(t) \cdot w_j \cdot \frac{\partial \Psi(\tau)}{\partial w_{jn}} \quad (11)$$

$$\frac{\partial E}{\partial b_{lj}} = - \sum_{i=1}^D e(t) \cdot w_j \cdot \frac{\partial \Psi(\tau)}{\partial b_{lj}} \quad (12)$$

$$\frac{\partial E}{\partial a_j} = - \sum_{i=1}^D e(t) \cdot w_j \cdot \frac{\partial \Psi(\tau)}{\partial a_j} \quad (13)$$

with :  $\tau = \frac{x-b_{lj}}{a_j}$

The incremental changes of each coefficient are simply the negative of their gradients.

$$\Delta w = -\eta_w \cdot \frac{\partial E}{\partial w} \quad (14)$$

$$\Delta a = -\eta_a \cdot \frac{\partial E}{\partial a} \quad (15)$$

$$\Delta b = -\eta_b \cdot \frac{\partial E}{\partial b} \quad (16)$$

The choice of  $\eta$  (learning rate) is empirical

If  $\eta$  is too small the number of iteration can be very high

**Table 3** Effect of wavelet type on the performance of WNN

WNN	Training error	Testing error
WNN-Gaussian	0.052	0.210
WNN-Mexican Hat	0.028	0.136
WNN-morlet	0.023	0.094
WNN-Meyer	0.030	0.131

If  $\eta$  is too large the progression of the algorithm may oscillate around a minimum without converging.

Thus each coefficient  $w$ ,  $a$  and  $b$  of the network is updated in accordance with the rule

$$w(n+1) = w(n) + \Delta w \quad (17)$$

$$a(n+1) = a(n) + \Delta a \quad (18)$$

$$b(n+1) = b(n) + \Delta b \quad (19)$$

### Implementation of the WNN heartbeats classifier and analysis

As stated before, the proposed method is used to classify five different categories of ECG heartbeats, the normal (N) and four pathological diseases. These are: the left bundle branch block beat (LBBB), the right bundle branch block beat (RBBB), the premature ventricular contraction (PVC) and the atrial premature contraction (APC). All the heartbeats used are collected from MIT-BIH arrhythmia database. A collection of 14 ECG records were selected provides a large set of normal and pathological heartbeats.

Table 1 illustrates the data distribution and the number of records used for the training and the evaluation of the WNN classifier.

For each class, 50% of the available heartbeats were used for training and the remaining 50% for testing the performance of the WNN heartbeats classifier (see Table 2).

### Analysis

The developed wavelet neural network (WNN) has been studied with different mother wavelets, Gaussian, Mexican Hat, Morlet and Meyer, in order to select the most appropriate for ECG beats recognition. This analysis was carried out according to the two steps in manipulating a neural network: the training step and the testing step. In

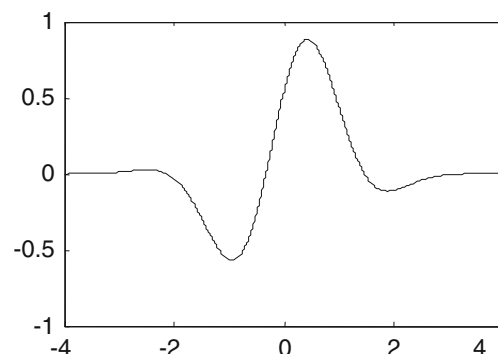
**Fig. 6** Morlet wavelet



**Table 4** Effect of number of hidden nodes on the performance of WNN

Number of hidden nodes	5	8	10	15	20
Training error	0.028	0.023	0.019	0.019	0.019
Testing error	0.115	0.094	0.086	0.089	0.089

fact, the appropriate wavelet is that which allowed the minimum values of respectively training and testing error.

The different tests carried out, as it is illustrated in Table 3 below, show that the WNN with Morlet mother wavelet provides minimum values of training and testing error leading therefore to better estimation of ECG beats (minimum value of testing error) recognition.

The Morlet wavelet is then used in our WNN. The Fig. 6 below illustrates the shape of this wavelet which is given by Eq. 20.

$$\Psi(t) = \cos(1.75 t) \cdot e^{-\frac{t^2}{2}} \tag{20}$$

The wavelet function is especially sensitive to scale coefficient and translation coefficient, therefore the determination of appropriate number of hidden layers is one of

the most critical tasks in neural network design. Unlike the input and output layers, one starts with no prior knowledge as to the number of hidden layers. A network with too few hidden nodes would be incapable of differentiating between complex patterns leading to only a linear estimate of the actual trend. In contrast, if the network has too many hidden nodes, it will follow the noise in the data due to over-parameterization, leading to poor generalization for untrained data. With increasing number of hidden layers, training becomes excessively time-consuming. The most popular approach to finding the optimal number of hidden layers is by trial and error [20, 21]. In this study one hidden layer having ten nodes were found to give the best result.

In fact, the trial method consists on implementing the network and changing the number of hidden nodes.

For each number of hidden nodes implemented, the training and testing error are measured. The considered number of hidden nodes is that which the training error and testing error are minimal as it is resumed in Table 4.

Initialization of the WNN parameters

The classification performance of the adaptive wavelet neural network (WNN) depends on the initialisation value of the network parameter to a certain degree [22].

WNN parameters need to be initialized properly during training for better convergence. A random initialization of all the parameters to small values is not desirable.

In the case of the neural networks with dorsal functions, the initialization of the network parameters is usually done randomly in such a way that the potential of each hidden neuron is small enough that the outputs of neurons located in the linear part of the sigmoid. The wavelet functions are rapidly decreasing, a random initialization of the translate and the scale parameters would be very inefficient. Indeed, if the translate parameters are initialized outside the area containing the examples, or if the scale parameters are

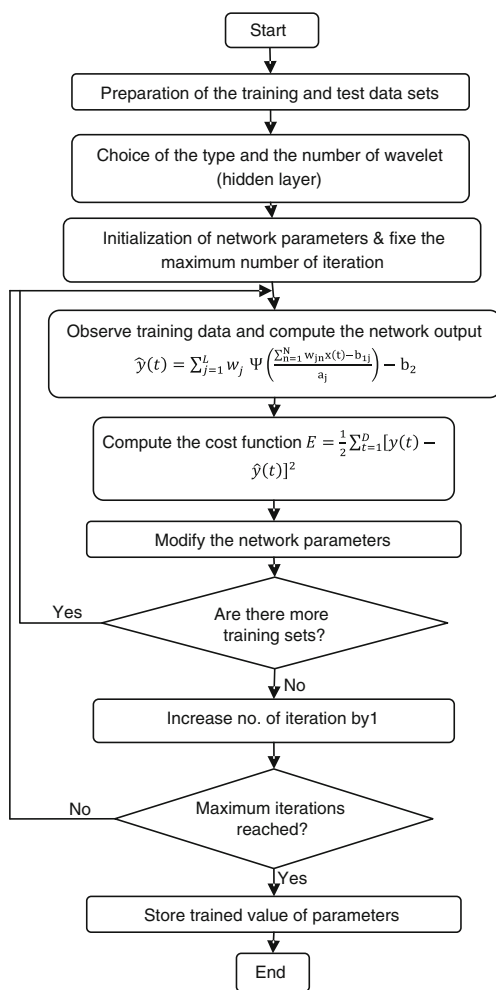

**Fig. 7** Flowchart of the Wavelet Network Algorithm

**Table 5** Confusion matrix of experiment

Confusion matrix	N	PVC	RBBB	LBBB	APC
N	4396	3	0	2	29
PVC	0	1362	1	2	10
RBBB	6	8	3529	42	0
LBBB	7	5	37	3256	0
APC	12	2	0	0	931

**Table 6** Classification results of different categories

Evaluate Terms	Type of beats	Number of correctly classified beats/ Total number of testing beats	Value (%)
Specificity	N	4396/4430	99.23
Sensitivity	PVC	1362/1375	99.05
	RBBB	3529/3585	98.43
	LBBB	3256/3305	98.51
	APC	931/945	98.51
Accuracy (%)	all	13474/13640	98.78

chosen too small, the output of the wavelet is practically zero, as well as its derivative.

The learning algorithm of the network parameters is based on a gradient technique; a particular attention should be paid to the phase of initialization of the network parameters.

Based on the work of Oussar [23], we propose a simple initialization procedure. It consists on considering the area where the training samples are distributed. It is carried out as follow:

$b_{1j}$ , the translate parameter of the wavelet transform is initialized on the center of the interval of the training example [23],

If  $[a, \beta]$  is the interval containing the input data (training example), the initial value of  $b_{1j}$  is choosen as:

$$b_{1j} = \frac{\alpha + \beta}{2} \tag{21}$$

The scale parameter  $a_j$  is chosen so that the variations of the wavelet stretch over the whole interval  $[a, \beta]$ . This condition is satisfied by the following choice [23]:

$$a_j = 0.2(\alpha + \beta) \tag{22}$$

The initialization of the other parameters (weight connection) is less significant than in the process of the

conduction of learning algorithm; they are initialized randomly between 0 and 1.

The whole procedure of the wavelet network is illustrated in the flowchart given in Fig. 7 below.

**Result**

The results of classification are resumed in Table 5 as a confusion matrix.

Each row of the matrix represents the instances in a predicted class, while each column represents the instances in an actual class. One benefit of a confusion matrix is that it is easy to see if the system is confusing two classes.

It is clearly seen that most wrongly classified normal beats are those classified as APC (29 beats). Whereas for the APC beats, most misclassified beats (12 beats) are classified as normal.

Similarly, the number of LBBB beats that are classified as RBBB beats and number of RBBB beats that are classified as LBBB beats are 37 and 42, respectively.

This is because of the morphological similarities between the Normal and APC patterns and between the LBBB and RBBB classes.

This highlights the importance of the five features that we have used in heartbeats characterization. These features improve the discriminating ability of the classifier, especially in discriminating morphologically similar heartbeat patterns (i.e. Normal and APC beats or LBBB and RBBB).

Small values of misclassified beats between PVC and respectively Normal (0 beat), RBBB (1 beat) or LBBB beats (2 beats) focuses on the morphological dissimilarities between the PVC beats and the other patterns.

Note that there is no APC beats that are classified as LBBB or RBBB, and there is no LBBB or RBBB beats that are classified as APC beats. This is because of the morphological dissimilarities between the APC and LBBB or RBBB patterns.

**Table 7** Comparative results of the ECG beat classification

Author. & Ref.	Method	Description	Accuracy (%)
Proposed	WNN	Wavelet neural network	98.78
Wen et al. [24]	SOCMAC	Self-Organizing Cerebellar Model Articulation Controller Network	98.21
Vargas et al. [25]	MLP	Principal Component Analysis (PCA) with Multi Layer Perceptron (MLP)	94.09
Minami et al. [26]	MLP	Fourier transform (FT) with Multi Layer Perceptron (MLP)	98
Lagerholm et al. [27]	SOM	Hermite functions and self organizing maps	98.49
Delgado et al. [28]	MART	Multichannel Adaptive Resonance Theory Neural Network	96.6
Linh et al. [29]	FCM+MLP	Fuzzy C-Mean with Multi Layer Perceptron (MLP)	93.5
Güler et al. [30]	MLP+MLP	Tow Multi Layer Perceptron (MLP)	96.94
Übeyli [31]	LE-ANFIS	Lyapunov Exponent with Adaptive Neuro Fuzzy Inference Network	96.39
Osowski [32]	HFNN	Hybrid Fuzzy Neural Network	96.06



## Evaluation

The results of classification can be also evaluated through well known performance parameters find in the literature. These are: *Accuracy*, *Specificity* and the *Sensitivity* for each type of pathology (PVC, RBBB, LBBB and APC). They are defined respectively as:

$$\text{Accuracy} = \frac{\text{Number of total correct classified beats}}{\text{Number of total beats}}$$

$$\text{Specificity} = \frac{\text{Number of correct classified Normal beats}}{\text{Number of total Normal beats}}$$

$$\text{Sensitivity} = \frac{\text{Number of correct classified pathological beats}}{\text{Number of total pathological beats}}$$

The results of the evaluation of the adaptive wavelet neural network (WNN) in terms of *Accuracy*, *Sensitivity* and *Specificity* are summarized in Table 6

Table 5 shows that the proposed method presents a high classification ability. The discrimination between the cardiac rhythms is very high for all classes. The method achieves overall accuracy of 98.78%. The results achieved by the proposed method are also compared with different neural networks found in the literature such as: Self-Organizing Cerebellar Model Articulation Controller Network (SOC-MAC) [24], Multi Layer Perceptron MLP [25, 26], Self Organization Map (SOM) [27], Multichannel Adaptive Resonance Theory Neural Network (MART) [28], combined neural network for ECG beat classification [29, 30], Adaptive neuro fuzzy inference network with lyapunov exponent LE-ANFIS [31] and Hybrid Fuzzy Neural Network (FNN) [32].

A summary of the results obtained for arrhythmic beat classification by the proposed method and the other methods is shown in Table 7.

It should be noted that in those works, though the ECG data all came from the MIT/BIH database, different number of clusters/classes, different recordings, different amount of data, and different signal conditioning methods and different feature extraction techniques are used. All these factors could affect the ECG beat classification result.

It is obvious from Table 7 that the results of the WNN-based classifier are relatively better than that the other neural network in terms of its correct classification percentage (Accuracy) of the ECG beats.

These results demonstrates that the proposed method has the potential for solving the problem of ECG beats recognition and can be considered as a powerful tool for the cardiac arrhythmias classification.

## Conclusion

This paper describes the details of development of a method for automatic classification of cardiac arrhythmia.

Our method includes two modules: feature extraction module and classifier.

In the feature extraction module we have extracted morphological features as the effective features for differentiating various types of ECG beats. Then, for the classification stage the wavelet neural network (WNN) is implemented and evaluated in ECG beats recognition of five different classes of ECG signals. The WNN is based on the combination of the wavelet theory with the neural networks.

The obtained result shows that the proposed method performs relatively better than some other neural network proposed in the literature.

It can therefore be considered as an effective tool for cardiac arrhythmias classification with high accuracy of over 98.78%.

These results are very promising and encourage us to extend this study to other biomedical as well as non-biomedical applications.

## References

1. Clifford, G. D., Azuaje, F., and McSharry, P. E., *Advanced methods and tools for ECG analysis*. Boston/London: Artech ouse Publishing, 2006:384.
2. de Chazal, P., O'Dwyer, M., and Reilly, R. B., Automatic classification of heartbeats using ECG morphology and heartbeat interval features. *IEEE Trans Biomed Eng* 51(7):1196–1206, 2004.
3. Bortolan, G., Brohet, C., and Fusaro, S., Possibilities of using neural networks for ECG classification. *J Electrocardiol* 29 (Supplement):10–16, 1996.
4. Minami, K., Nakajima, H., and Toyoshima, T., Real-time discrimination of ventricular tachyarrhythmia with fourier-transform neural network. *IEEE Trans Biomed Eng* 46(2):179–185, 1999.
5. Qin, S., Ji, Z., and Zhu, H., The ECG recording analysis instrumentation based on virtual instrument technology and continuous wavelet transform, Proceedings of the 25th Annual International Conference of the IEEE EMBS Cancun, Mexico, September 17–21, 2003, pp. 3176–3179.
6. Dickhaus, H., and Heinrich, H., Classifying biosignals with wavelet networks—a method for noninvasive diagnosis, IEEE Engineering in Medicine and Biology, September/October 1996, pp. 103–111.
7. Lin, C.-H., Du, Y.-C., and Chen, T., Adaptive wavelet network for multiple cardiac arrhythmias recognition. *Expert Syst Appl* 34 (4):2601–2611, 2008.
8. Wang, Y., Zhu, Y.-S., Thakor, N. V., and Xu, Y.-H., A short-time multifractal approach for arrhythmias detection based on fuzzy neural network. *IEEE Trans Biomed Eng* 48(9):989–995, 2001.
9. Lin, C.-H., Classification enhancible grey relational analysis for cardiac arrhythmias discrimination. *Med Biol Eng Comput* 44 (4):311–320, 2006.
10. Mazel, D. S., and Hayes, M. H., Using iterated function systems to model discrete sequences. *IEEE Trans Signal Processing* 40 (7):1724–1734, 1992.
11. Vines, G., and Hayes, M. H., III, Nonlinear address maps in a one-dimensional fractal model. *IEEE Trans Signal Process* 41 (4):1721–1724, 1993.
12. Barnsley, M., Fractal functions and interpolation. *Constr Approx* 2:303–329, 1986.
13. Barnsley, M., *Fractals everywhere*. Academic, New York, 1988.

14. Lin, C.-H., and Wang, C.-H., Adaptive wavelet networks for power quality detection and discrimination in a power system. *IEEE Trans Power Delivery* 21(3):1106–1113, 2006.
15. Hadj Slimane, Z., and Bereksi Reguig, F., New algorithm for QRS complex detection. *J Mech Med Biol (JMMB)* 5(4):507–515, 2005.
16. So, H. H., and Chan, K. L., Development of QRS detection method for real-time ambulatory cardiac monitor. *Proc 19th Annu Int Conf IEEE EMBS*. Chicago, USA, 289–292, 1997.
17. Zhang, J., Walter, G. G., Miao, Y., and Lee, W. N. W., Wavelet neural networks for function learning. *IEEE Trans Signal Processing* 43:1485–1497, 1995.
18. MIT BIH Arrhythmia Database Directory. Physiobank Archive Index, MIT-BIH Arrhythmia Database. Available: <<http://www.physionet.org/physiobank/database>>.
19. Zhang, Q., Using wavelet network in nonparametric estimation. *IEEE Trans on Neural Networks* 8(2):227–236, 1997.
20. Basheer, I. A., and Hajmeer, M., Artificial neural networks: fundamentals, computing, design, and application. *J Microbiol Meth* 43:3–31, 2000.
21. Haykin, S., *Neural networks: a comprehensive foundation*. Macmillan, New York, 1994.
22. Szu, H. H., et al., Neural network adaptive wavelets for signal representation and classification. *Optical eng* 31(9):1907–1916, 1992.
23. Yacine, O., Réseaux d'ondelettes et réseaux de neurones pour la modélisation statique et dynamique de processus. *Thèse de Doctorat de l'UNIVERSITÉ PIERRE ET MARIE CURIE (PARIS VI)*. Spécialité ROBOTIQUE, 1998.
24. Cheng, W., et al., Classification of ECG complexes using self-organizing CMAC. *J Meas* 42:399–707, 2009.
25. Vargas, F., Lettnin, D., de Castro, M. C. F., and Macarthy, M., Electrocardiogram pattern recognition by means of MLP network and PCA: a case study on equal amount of input signal types. *Proceedings of the VII Brazilian Symposium on Neural Networks*, 2002.
26. Minami, K., Nakajima, H., and Toyoshima, T., Real-time discrimination of ventricular tachyarrhythmia with Fourier-transform neural network. *IEEE Trans Biomed Eng* 46(2):179–185, 1999.
27. Lagerholm, M., Peterson, C., Braccini, G., Edenbrandt, L., and Sörnmo, L., Clustering ECG complexes using Hermite functions and self organizing maps. *IEEE Trans Biomed Eng* 47(7):838–848, 2000.
28. Fernández-Delgado, M., and Ameneiro, S. B., MART: a multi-channel ART based neural network. *IEEE Trans Neural Netw* 9(1):139–150, 1998.
29. Linh, T. H., Osowski, S., and Stodolski, M., On-line heart beat recognition using Hermite polynomials and neuro-fuzzy network. *IEEE Trans Instrum Meas* 52:1224–1231, 2003.
30. Güler, I., and Übeyli, E. D., ECG beat classifier designed by combined neural network model. *Pattern Recognit* 38(2):199–208, 2005.
31. Ubeyli, E. D., Adaptive neuro-fuzzy inference system for classification of ECG signals using Lyapunov exponents. *Comput Meth Programs Biomed* 93:313–321, 2009.
32. Osowski, S., and Linh, T. H., ECG beat recognition using fuzzy hybrid neural network. *IEEE Trans Biomed Eng* 48:1265–1271, 2001.

## CARDIAC ARRHYTHMIA DIAGNOSIS USING A NEURO-FUZZY APPROACH

R. BENALI\*, N. DIB and F. REGUIG BEREKSI†

*GBM Laboratory, Tlemcen University*

*\*benali\_redouane@yahoo.fr*

*†f\_bereksi@mail.univ-tlemcen.dz*

Received 14 August 2009  
Accepted 10 November 2009

The ventricular premature contractions (VPC) are cardiac arrhythmias that are widely encountered in the cardiologic field. They can be detected using the electrocardiogram (ECG) signal parameters. A novel method for detecting VPC from the ECG signal is proposed using a new algorithm (Slope) combined with a fuzzy-neural network (FNN).

To achieve this objective, an algorithm for QRS detection is first implemented, and then a neuro-fuzzy classifier is developed. Its performances are evaluated by computing the percentages of sensitivity (SE), specificity (SP), and correct classification (CC). This classifier allows extraction of rules (knowledge base) to clarify the obtained results. We use the medical database (MIT-BIH) to validate our results.

*Keywords:* ECG QRS detection; neuro-fuzzy; fuzzy logic; VPC; explicit classification; MIT-BIH database.

### 1. Introduction

The electrocardiogram (ECG) records the electrical activities of the heart. The normal ECG is constituted by successive waveforms: P, QRS complex, and T wave. Where the P wave represents atrial depolarization, the QRS complex, the ventricular depolarization, and the T wave the ventricular repolarization. Thus, ECG is an important noninvasive clinical tool for the diagnosis of heart diseases. Indeed, the presence of a cardiac disease introduces the modification of P, QRS, or T wave shapes, sizes, and duration. Recently, the computer-assisted ECG analysis is widely used to recognize cardiac pathologies.

Therefore, several methods and techniques have been developed for the detection of the cardiac abnormalities and different approaches from pattern recognizing, machine learning, and expert systems have been used in intelligent diagnostic systems.

\*,†Corresponding authors.

The cardiac arrhythmia signifies a disorder of cardiac rhythm that can be calculated from the successive localization of R peaks. Consequently, the QRS complex seems to be the most important component in cardiac arrhythmia recognition. Thus, the detection of R peaks represents the second steps in most of ECG analysis algorithms. The first step is generally related to the noise filtering. Many researches are devoted to the complex QRS identification. Ruha *et al.* had developed a QRS detection algorithm based on optimized filtering and an amplitude comparison to an adaptive threshold.<sup>1</sup> The thresholding decision is also used. The wavelet transformation is also adopted in some QRS detection algorithms.<sup>2,3</sup> Besides the previous methods, the mathematical morphology operators are used for the QRS complex detection.<sup>4</sup>

The neural network is also a useful method for QRS detection. However, when it is used for ECG classification, the results of the neural network method are considered as noninterpretive results.

On the contrary, the fuzzy-neural network (FNN) allows the interpretation of the obtained results. In this paper, a FNN is used to recognize ventricular premature contraction (VPC). For that, an algorithm is first developed used to detect the QRS complex.

Then, the input parameters for the FNN are calculated. The evaluation of the implemented model is carried out on the universal MIT-BIH database.<sup>5</sup> The obtained results are compared with some algorithms existing in the literature.

## 2. Method

In this work, the proposed procedure is illustrated in Fig. 1 for the automatic recognition of the normal and abnormal ECG beats. It consists of the following steps:

- ECG data pre-processing,
- feature extraction, and
- neuro-fuzzy classifier.

### 2.1. ECG signal collection

The ECG signals used in this work are recordings collected between 1975 and 1979 by the laboratory of BIH arrhythmia (Beth Israel Hospital) in Boston in the United

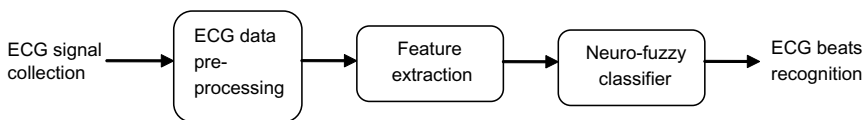

Fig. 1. Block diagram of the proposed method.

States, which is known as the MIT-BIH database.<sup>5</sup> The ECG signals are sampled at a frequency of 360 Hz. Two or more cardiologists have made the diagnosis for these various records and they have annotated each cardiac cycle. These annotations will be useful for learning and assessment of the classification.

**2.2. ECG data pre-processing**

The first step of signal pre-processing is filtering the ECG signal; because, like other measured signals, ECG is also contaminated with high frequency noise. The unwanted noise of the heart biopotential signal must be removed. ECG signals are filtered using a bandpass filter between 0.05 Hz and 100 Hz to eliminate the motion artifact, baseline wander and 50 Hz notch filter to eliminate power-line noise.

**2.3. ECG features extraction**

The important step in building an efficient classifier system is the generation of the diagnostic features, based on which the classifier will recognize the pattern. The benefit of the proposed algorithm lies in its simplicity and its good accuracy to detect QRS complex. The QRS complex detection algorithm is based on a developed “modified So and Chan” algorithm.<sup>6</sup>

The algorithm benefits from the steep slope of the QRS complex for its detection. As a first step, the ECG slope is calculated approximately as:

$$\text{slope}(i) = 2x(i + 2) + x(i + 1) - x(i - 1) - 2x(i - 2), \tag{1}$$

where,  $x(n)$  represents the amplitude of ECG data at discrete time  $n$ .

Then, the adaptive threshold is defined as follows:

$$\text{slope\_thresh} = \frac{\text{thresh\_param}}{16} * \max i, \tag{2}$$

where

$$\text{thresh\_param} = 2, 4, 8, \text{ or } 16. \tag{3}$$

The parameter  $\max i$  is update by:

$$\max i = \frac{\text{first\_max } i - \max i}{\text{filter\_param}} + \max i, \tag{4}$$

where

$$\text{first\_max } i = \text{height of R point} - \text{height of QRS onset}. \tag{5}$$

The QRS complex detection is done by comparing the ECG slope values with the adaptive thresholds. Indeed, the Q onset “Q\_on” is located when two successive values of the above slope exceed an adaptive threshold. For more accuracy, we have defined Q\_on wave as the first deflection just before the Q wave as it is illustrated

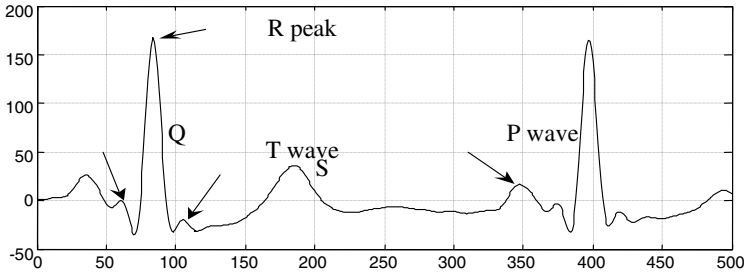

Fig. 2. ECG of a health person.

in Fig. 2. To achieve this accuracy, a first derivative of the ECG slope is calculated as follows:

$$\text{min\_slope} (i) = |\text{slope} (i) - \text{slope} (i + 1)|. \tag{6}$$

The  $Q_{on}$  is considered as the point for which the amount “min\_slope” takes its minimum. If no deflection is detected, the  $Q_{on}$  is considered as Q wave itself.

After the detection of the  $Q_{on}$  point, the R peak is located. It is taken as the maximum point within a determined window after the Q wave.

To detect the  $j$  point, the detection of S wave is needed. The first zero crossing after the R peak is detected. The S wave is localized as the minimum after the first zero crossing. Then, the  $j$  point is taken as the first deflection after the S wave. Indeed, the  $j$  point is taken as the first point that satisfies the following relations:

$$\text{slope} (i) > 0 \quad \text{and} \quad \text{slope} (i + 1) < 0. \tag{7}$$

#### 2.4. ECG beats classification using a neuro-fuzzy classifier

In this work, we classify the VPC by a neuro-fuzzy approach using the adaptive neuro-fuzzy inference system (ANFIS). Both neural networks and fuzzy logic are universal estimators. They can approximate any function to any prescribed accuracy, provided that sufficient hidden neurons and fuzzy rules are available.

Neural networks have been the subject of biomedical research interest during the past decade.<sup>7-10</sup> But, this technique is considered as a black box because it cannot justify its results. However, fuzzy set theory plays an important role in dealing with uncertainty like making decisions in medical applications.<sup>11,12</sup> The fuzzy inference systems (FIS) can interpret their results through their knowledge base (basic rules).<sup>13</sup> Recent results show that the fusion procedure of these two approaches (neuronal and fuzzy approaches) seems to be very effective for the pattern recognition.



2.4.1. Presentation of the neuro-fuzzy approach

Neuro-fuzzy systems are fuzzy systems that use neural networks theory in order to determine their properties (fuzzy sets and fuzzy rules) by processing data samples. Neuro-fuzzy systems harness the power of the two paradigms: fuzzy logic and neural networks, by utilizing the mathematical properties of neural networks in tuning rule-based fuzzy systems that approximate the way human beings process information.<sup>7</sup> Successful implementation of neuro-fuzzy systems have been introduced by several authors, for example, Buckley and Hayashi, Nauck and Kruse, and Belal *et al.*<sup>14–16</sup>

In this work, we present the ANFIS approach that is a neuro-fuzzy hybrid method proposed by Jang.<sup>17,18</sup> It is the most widely used of neuro-fuzzy techniques to solve problems of classification and pattern recognition.

2.4.1.1. ANFIS structures

The ANFIS is a FIS based on the model of Takagi-Sugeno<sup>17</sup> and uses five layers. For reasons of representation, we will consider a system with two inputs and one output and also consider a model of the first order using two rules:

If  $x_1$  is  $A_1$  and  $x_2$  is  $B_1$ , then  $y_1 = f_1(x_1, x_2) = a_1x_1 + b_1x_2 + c_1$ .

If  $x_1$  is  $A_2$  and  $x_2$  is  $B_2$ , then  $y_2 = f_2(x_1, x_2) = a_2x_1 + b_2x_2 + c_2$ .

The ANFIS architecture that allows representing the basic rules is carried out by an adaptive network that contains fixed nodes (circular) and adaptive nodes (square) as illustrated in Fig. 3.

Each node square or circular applies a function on its input signals and for a given layer, nodes have the same type of function. The output  $O_i^k$  of a node  $i$  of the  $k$  layer (called node  $(i, k)$ ) depends on the signals from the layer  $k - 1$  and parameters of the node  $(i, k)$ .

$$O_i^k = f(O_1^{k-1} \dots O_{n_{k-1}}^{k-1}, a, b, c, \dots). \tag{8}$$

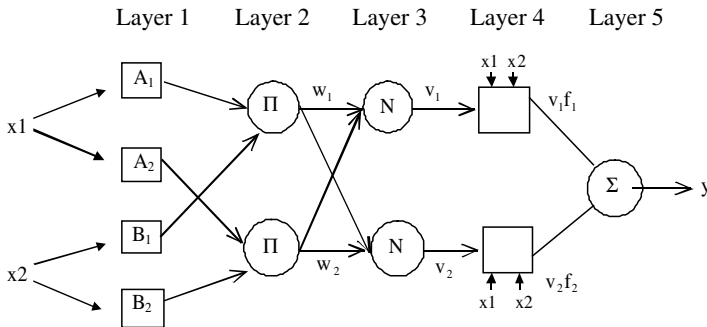

Fig. 3. ANFIS architecture.

$n_{k-1}$  is the number of nodes in the  $(k - 1)$  layer, and  $a, b$ , and  $c$  are the parameters of the  $(i, k)$  node. It should be noted that a circular node has no parameters.

Layer 1.

Nodes of this layer are all adaptive nodes. This layer performs fuzzification of the inputs; it determines the membership of each input:

$$O_i^1 = \mu_{A_i}(x), \tag{9}$$

where  $x$  is input of  $i$  node,  $A_i$  is linguistic variable, and  $O_i^1$  is the degree of membership of  $x$  to  $A_i$ .

The parameters of a node in this layer are those of the corresponding membership function, these are the premise parameters.

Layer 2.

The nodes of this layer are fixed nodes. They receive the output signals from the previous layer and send their product output

$$w_i = \mu_{A_i}(x_1) \cdot \mu_{B_i}(x_2) \quad i = 1, 2 \tag{10}$$

where  $w_i$  is the degree of truth of the rule  $i$ .

Layer 3.

Each neuron in this layer calculates the normalized degree of truth of the fuzzy rule.

$$v_i = \frac{w_i}{w_1 + w_2}. \tag{11}$$

The result out of each node represents the contribution of this rule on the final result.

Layer 4.

The nodes in this layer are adaptive and perform the consequent of the rules. The output of a node  $i$  is given by:

$$O_i^4 = v_i \cdot f_i = v_i(a_i x_1 + b_i x_2 + c_i) \quad i = 1, 2. \tag{12}$$

The parameters in this layer  $(a_i, b_i, c_i)$  are to be determined and are referred to as the consequent parameters.

Layer 5.

This layer consists of a single neuron circular that makes the sum of signals from the previous layer to give the final output of the network:

$$O_1^5 = y = \sum_i v_i \cdot f_i. \tag{13}$$

The generalization of the system to a system with multiple inputs does not pose any problem. The number of nodes in the first layer is always equal to the total number of defined linguistic terms.

### 2.4.1.2. ANFIS learnings

There are several learning algorithms for a neuro-fuzzy model.<sup>19</sup> Jang proposed a learning method called “hybrid algorithm.” This algorithm combining the least square method and the gradient descent method is adopted to solve this problem. The hybrid algorithm is composed of a forward pass and a backward pass. The least square method (forward pass) is used to optimize the consequent parameters with the premise parameters fixed. Once the optimal consequent parameters are found, the backward pass starts immediately. The gradient descent method (backward pass) is used to adjust optimally the premise parameters corresponding to the fuzzy sets in the input domain. The output of the ANFIS is calculated by employing the consequent parameters found in the forward pass. The output error is used to adapt the premise parameters by means of a standard back propagation algorithm. It has been proven that this hybrid algorithm is highly efficient in training the ANFIS.<sup>17,18</sup>

## 3. Result

In this work, we try to detect the VPC. The choice of descriptive parameters that are the input vector is dictated by the nature of the pathology targeted,<sup>20,21</sup> and the result of previous step (features extraction).

For describing the heartbeat, we have chosen:

- RRp: the distance between the current R-wave and the previous R-wave.
- RRs: the distance between the current R-wave and the following R-wave.
- RRs/RRp: the ratio between the distance RR following the previous one.
- QRS: the duration of the QRS complex.

The database built is used for learning and testing the classifier. Patients selected to build the database are patients who have diseases targeted (VPC). They are presented in Table 1.

From the ECG data present in Table 1, we choose randomly 1000 beats for each of the two classes (normal and VPC) (2000 beats to form the learning base). From the learning database, we generate an initial FIS of Sugeno type zero order (Fig. 4)

Table 1. Number of beats for each record.

Records	N	VPC
100	2225	1
116	2175	108
200	1726	815
201	1325	176
209	1850	1
210	2100	181
223	1986	449
233	1029	813
234	1700	3
<b>Total</b>	<b>16116</b>	<b>2548</b>

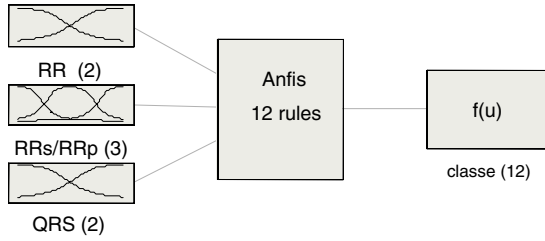

Fig. 4. Initial neuro-fuzzy model.

with the initial choices includes (based on the knowledge of the physician):

1. Membership function type: “gbell.”<sup>17</sup>
2. Number of membership function for each variable.
  - RRp: two functions,
  - RRs/RRp: three functions,
  - QRS: two functions.
3. Manual initialization of modal points, based on knowledge of the expert (physician).

At the end of the learning, parameters of the initial membership functions (Fig. 5(a)) will be modified as shown on Fig. 5(b).

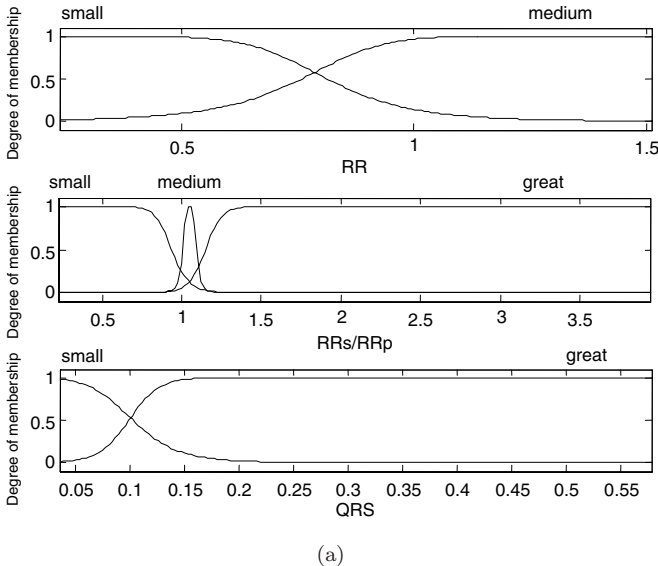
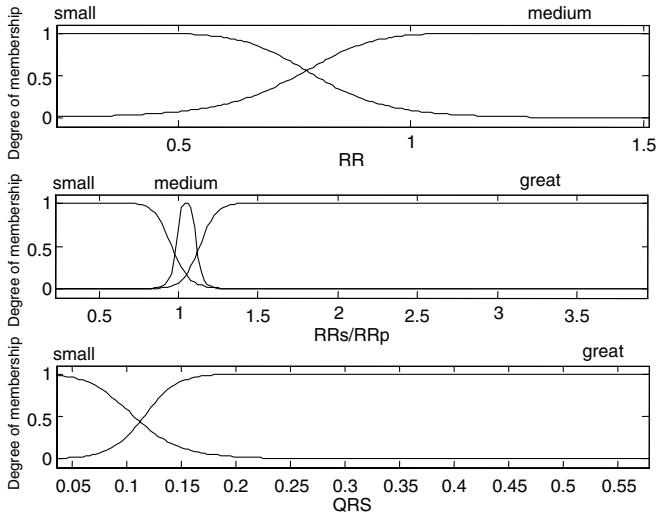

Fig. 5. (a) Initial membership functions and (b) final membership functions (after learning).



(b)

Fig. 5. (Continued)

### 3.1. Evaluation of the performance

The performance of the neural classifiers was evaluated by computing the percentages of sensitivity (SE), specificity (SP), and correct classification (CC); the respective definitions are as follows:

- *Sensitivity (SE %)*:  $[SE = 100 \times TP / (TP + FN)]$  is the fraction of real events that are correctly detected among all real events.
- *Specificity (SP %)*:  $[SP = 100 \times TN / (TN + FP)]$  is the fraction of nonevents that has been correctly rejected.
- *Correct classification (CC %)*:  $[CC = 100 \times (TP + TN) / (TN + TP + FN + FP)]$  is the classification rate.

In these formulas, TP is the number of true positives, TN is the number of true negatives, FN is the number of false negatives, and FP is the number of false positives.

Since we are interested in estimating the performance of the classifier based on the recognition of VPC beats, TP, FP, TN, and FN are defined appropriately as shown below:

- TP: classifies VPC as VPC,
- FP: classifies normal as VPC,
- TN: classifies normal as normal, and
- FN: classifies VPC or normal.

Table 2. Performances of the neuro-fuzzy classifier (%).

Records	SP (%)	SE (%)	CC (%)
100	99.45	97.86	100.00
116	99.87	98.16	99.95
200	99.89	99.54	99.86
201	95.59	97.80	94.64
209	99.50	89.88	100.00
210	95.91	93.25	97.79
223	99.15	99.14	99.15
233	99.43	96.49	99.52
234	99.75	99.23	100.00
<b>Average</b>	<b>98.48</b>	<b>98.23</b>	<b>98.71</b>

Table 3. Summary of the results obtained the proposed and other methods.

Authors	SP (%)	SE (%)	Method description	Interpretation of result
Our method	98.48	98.23	Neuro-fuzzy approach	Yes
Wieben <sup>22</sup>	—	85.30	Filter bank features and decision tree classifier	No
Moreas <sup>23</sup>	99.76	90.74	Real-time QRS delineation and application of Mahalanobis distance classifier	No
Christov <sup>24</sup>	99.70	98.50	Estimation of morphology features with neural networks classifier	No
De Chazal <sup>25</sup>	98.80	77.70	Estimation of morphology and RR interval features with linear discrimination classifier	No
Tsipouras <sup>26</sup>	—	96.43	Expert system based on fuzzy logic	Yes
Exarchos <sup>27</sup>	—	96.00	Expert system based on fuzzy logic	Yes

The results of the evaluation of the neuro-fuzzy classifier in terms of CC, SE, and SP are summarized in Table 2.

A summary of the results obtained for arrhythmic beat classification by the proposed method and other methods is shown in Table 3.

By comparing our results with those of literature, we find that we have not achieved the best results in term of classification (the results of Christov *et al.*<sup>24</sup> are the bests), but our technique allows the extraction of rules (knowledge base) to clarify the results obtained (this characteristic is absent for the other methods except the work of Tsipouri *et al.*,<sup>26,27</sup> which have a rate of classification much worse than the others methods).

Our neuro-fuzzy classifier allows automatically the generation of a knowledge base (48 rules) to justify the classification. This database is considered as an advantage for this classifier compared to other technique. In fact, it allows the interpretability of the results after the classification. Our method generates



automatically a knowledge base (12 rules) to justify the classification. The rule base generated by the neuro-fuzzy classifier is:

1. If (RRP is small) and (RRS/RRP is small) and (QRS is small), then (class is N).
2. If (RRP is small) and (RRS/RRP is small) and (QRS is great), then (class is VPC).
3. If (RRP is small) and (RRS/RRP is medium) and (QRS is small), then (class is N).
4. If (RRP is small) and (RRS/RRP is medium) and (QRS is great), then (class is VPC).
5. If (RRP is small) and (RRS/RRP is great) and (QRS is small), then (class is VPC).
6. If (RRP is small) and (RRS/RRP is great) and (QRS is great), then (class is VPC).
7. If (RRP is average) and (RRS/RRP is small) and (QRS is small), then (class is N).
8. If (RRP is average) and (RRS/RRP is small) and (QRS is great), then (class is VPC).
9. If (RRP is average) and (RRS/RRP is medium) and (QRS is small), then (class is N).
10. If (RRP is average) and (RRS/RRP is medium) and (QRS is great), then (class is VPC).
11. If (RRP is average) and (RRS/RRP is great) and (QRS is small), then (class is N).
12. If (RRP is average) and (RRS/RRP is great) and (QRS is great), then (class is VPC).

The generated rules are very close to the reasoning of the human expert (cardiologist).

#### **4. Conclusion**

This paper presents a system that is based on the application of a hybrid approach called neuro-fuzzy, which combines neural networks with fuzzy logic for reliable heartbeat classification based on the ECG waveform. This approach generates very good results with an average CC rate of 98.71%, in addition to the justification of decisions taken in the neuro-fuzzy classifier using its rule base (12 rules). These rules are very consistent and closer to the cardiologist reasoning.

The results obtained are very promising and encourage us to extend this study to other types of cardiac arrhythmias. Such neuro-fuzzy classifier can be easily hardware implemented (real-time response) and used in intensive care units.

## References

1. Ruha A, Sallinen S, Nissila S, A real time microprocessor QRS detector system with a 1 ms timing accuracy for the measurement of ambulatory HRV, *IEEE Trans Biomed Eng* **44**(3), March 1997.
2. Dinh HAN *et al.*, Wavelets for QRS detection, *The 23rd Annual EMBS International Conference*, Istanbul, Turkey, October 25–28, 2001.
3. Mohamoodabadi Ahmadian SZ, Abolhasani MD, ECG feature extraction using Daubechies wavelets, *Proceeding of the Fifth IASTED International Conference, Visualization, Imaging, and Image Processing*, Benidorm, Spain, September 7–9, 2005.
4. Trahanias PE, An approach to QRS complex detection using mathematical morphology, *IEEE Trans Biomed Eng* **40**(2), 1993.
5. MIT BIH Arrhythmia Database Directory, Physiobank Archive Index, MIT-BIH Arrhythmia Database, Available at <http://www.physionet.org/physiobank/database>.
6. Chan KL, So H, Development of QRS method for real-time ambulatory cardiac monitor, *Proceeding of the 19th Annual International Conference IEEE EMBS*, Chicago, USA, pp. 289–292, 1997.
7. Güler I, Übeyli ED, Application of adaptive neuro fuzzy inference system for detection of electrocardiographic changes in patients with partial epilepsy using feature extraction, *Expert Syst Appl* **27**:323–330, 2004.
8. Yu S-N, Chou K-T, Integration of independent component analysis and neural networks for ECG beat classification, *Expert Syst Appl* **34**(4), 2007.
9. Übeyli ED, Güler I, Neural network analysis of internal carotid arterial Doppler signals: Predictions of stenosis and occlusion, *Expert Syst Appl* **25**(1):1–13, 2003.
10. Zhou J, Automatic determining of premature ventricular contraction using quantum neural networks, *Proceedings of the 3rd IEEE Symposium on Bioinformatics and Bioengineering BIBE'03*, pp. 169–173, 10–12 March 2003.
11. Nauck D, Kruse R, Obtaining interpretable fuzzy classification rules from medical data, *Artif Intell Med* **16**:149–169 1999.
12. Anuradha B, Cardiac arrhythmia classification using fuzzy classifiers, *J Theor Appl Inf. Technol* **4**(4), 2008.
13. Benali R, Chikh MA, Neuro-fuzzy classifier for cardiac arrhythmias recognition, *J Theor Appl Inf Technol* **5**(5):577–583, 2009.
14. Buckley JJ, Hayashi Y, Neural nets for fuzzy systems, *Fuzzy Set Syst* **71**:265–276, 1995.
15. Nauck D, Kruse R, NEFCLASS — A neuro-fuzzy approach for the classification of data, in *ACM Symposium on Applied Computing*, Nashville, New York, pp. 461–465, February, 1995.
16. Belal SY, Taktak AFG, Nevill AJ, Spencer SA, Roden D, Bevan S, Automatic detection of distorted plethysmogram pulses in neonates and paediatric patients using an adaptive-network-based fuzzyinference system, *Artif Intell Med* **24**:149–165.
17. Jang RJS, ANFIS adaptive-network-based fuzzy inference systems, *IEEE Trans Syst Man Cyb* **23**(3):665–685, 1993.
18. Jang JSR, Sun CT, Muzutani E, *Neuro-Fuzzy and Soft Computing — A Computational Approach to Learning and Machine Intelligence*, Pearson Education Inc., 2007.
19. Glorennec PY, Learning algorithms for neuro-fuzzy networks, in Kandel A, Langholz G (eds.), *Fuzzy Control Systems*, CRC Press, New York, pp. 4–18, 1994.
20. Chikh MA, Analyse du signal ECG par les reseaux de neurons et la logique floue: Application à la reconnaissance des VPC, Doctorate Thesis, Tlemcen University, 2005.

21. Chikh MA, Bereksi Reguig F, Application of artificial neural networks to identify the premature ventricular contraction (VPC) beats, *Electron J "Technical Acoustics."* Available at <http://www.ejta.org>, 2004.
22. Wieben O, Afonso V, Tompkins W, Classification of premature ventricular complexes using filter bank features, induction of decision trees and a fuzzy rule-based system, *Med Biol Eng Comput* 560–565, 1999.
23. Moreas JCTB, Seixas MO, Vilani FN, Costa EV, A real time QRS complex classification method using Mahalanobis distance, *Comput Cardiol* 201–204, 2002.
24. Christov I, Bortolan G, Ranking of pattern recognition parameters for premature ventricular contraction classification by neural networks, *Physiol Meas* 1281–1290, 2004.
25. De Chazal P, O'Dwyer M, Reilly R, Automatic classification of heartbeats using ECG morphology and heart beat interval features, *IEEE Trans Biomed Eng* 1196–1206, 2004.
26. Tsipouras MG, Voglis C, Fotiadis DI, A framework for fuzzy expert system creation — application to cardiovascular diseases, *IEEE Trans Biomed Eng* 2089–2105, 2007.
27. Exarchos TP, Tsipouras MG, Exarchos CP, Papaloukas C, Fotiadis DI, Michalis LK, A methodology for the automated creation of fuzzy expert systems for ischaemic and arrhythmic beat classification based on a set of rules obtained by a decision tree, *Artif Intell Med* 187–200, 2007.
28. Benali R, Chikh MA, Extraction des connaissances et classification des données médicales, *National Seminar of Informatics in Biskra*, Algeria, 2008.

# NEURO-FUZZY CLASSIFIER FOR CARDIAC ARRHYTHMIAS RECOGNITION

<sup>1</sup>R. BENALI, <sup>2</sup>M. A. CHIKH

<sup>1,2</sup> «Genie Biomedical Laboratory Tlemcen University »

E-mail : <sup>1</sup>[r\\_benali@mail.univ-tlemcen.dz](mailto:r_benali@mail.univ-tlemcen.dz) <sup>2</sup>[mea\\_chikh@mail.univ-tlemcen.dz](mailto:mea_chikh@mail.univ-tlemcen.dz)

## ABSTRACT

The premature ventricular contraction (PVC) and the premature atrial contraction (PAC) are cardiac arrhythmias which are widely encountered in the cardiologic field. They can be detected using the electrocardiogram signal parameters. We use in this work a Neuro-fuzzy approach to identify these abnormal beats. To achieve this objective we have developed a Neuro-Fuzzy Classifier (NFCL), its performances were evaluated by computing the percentages of sensitivity (Se), specificity (Sp) and correct classification (CC). This classifier allows extraction of rules (knowledge base) to clarify the results obtained. We use the medical database (MIT-BIH) to validate our results.

**Keywords :** ECG, neuro-fuzzy, fuzzy logic, PVC, PAC, explicit classification, MIT-BIH data base.

## 1. INTRODUCTION

The Holter exam which is widely used in cardiology is a tool of recording electrocardiogram (ECG) of long duration. It facilitates the diagnosis of cardiac arrhythmias. Due to large number of patients in intensive care units and the need for continuous observation of such condition, several methods and techniques for automated ECG beats recognition have been developed in the past ten years to look for solutions to this problem ([1] [2] [3]).

The electrocardiogram ECG is a physiological signal that represents the mechanical heart (contraction and relaxation). Figure (1) shows an ECG pattern for healthy subjects.

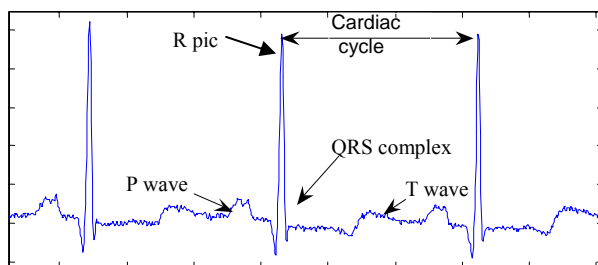

Fig1: ECG of a health person

We can see different waves in an ECG signal:

- P wave: is the contraction of the atria.
- QRS Complex: equivalent to a contraction of the ventricles.
- T wave: is the relaxation of ventricles.

The PVC and PAC premature beats are appearing with Normal beats (N) on the ECG signal (Figure 2 and 3)

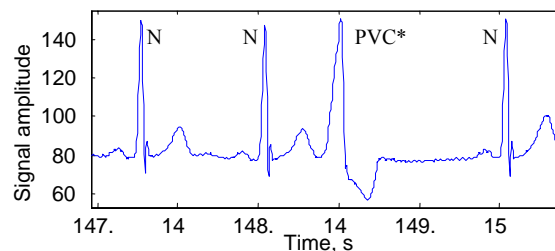

Fig.2 The premature ventricular contraction (PVC)

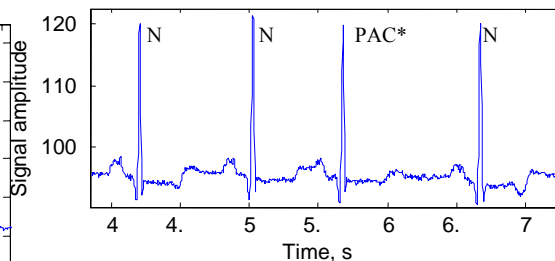

Fig.3 The premature atrial contraction (PAC).

Both neural networks and fuzzy logic are universal estimators. They can approximate any function to any prescribed accuracy, provided that

sufficient hidden neurons and fuzzy rules are available.

Neural networks have been the subject of biomedical research interest during the past decade ([4] [2] [3] [1]). But this technique is considered as a black box because it can't justify its results. However, fuzzy set theory plays an important role in dealing with uncertainly like making decisions in medical applications ([5] [6]). The fuzzy inference systems can interpret their results through their knowledge base (basic rules) [7].

Recent results show that the fusion procedure of these two approaches (neuronal and fuzzy approach) seems to be very effective for the pattern recognition.

## 2. PRESENTATION OF THE NEURO-FUZZY APPROACH

Neuro-fuzzy systems are fuzzy systems which use neural networks theory in order to determine their properties (fuzzy sets and fuzzy rules) by processing data samples. Neuro-fuzzy systems harness the power of the two paradigms: fuzzy logic and neural networks, by utilizing the mathematical properties of neural networks in tuning rule-based fuzzy systems that approximate the way man processes information [1].

Successful implementation of neuro-fuzzy systems have been introduced by several authors, as ([10] [8] [9]).

In this work we present the ANFIS approach (adaptive neuro fuzzy inference system) which is a neuro-fuzzy hybrid method proposed by Jang [12] [11], and it is the most widely used of neuro-fuzzy techniques and the best one to solve problems of classification and Pattern Recognition.

### 2.1. ANFIS structure's

The ANFIS is a fuzzy inference system based on the model of Takagi-Sugeno [11] and uses five layers.

For reasons of representation, we will consider a system with two inputs and one output and also consider a model of the 1st order using two rules:

If  $x_1$  is  $A_1$  and  $x_2$  is  $B_1$  then  $y_1=f_1(x_1,x_2) = a_1x_1 + b_1x_2 + c_1$ .

If  $x_1$  is  $A_2$  and  $x_2$  is  $B_2$  then  $y_2=f_2(x_1,x_2) = a_2x_1 + b_2x_2 + c_2$ .

The ANFIS architecture that allows representing the basic rules is carried out by an adaptive network

that contains fixed nodes (circular) and adaptive nodes (square) as illustrated in figure.4.

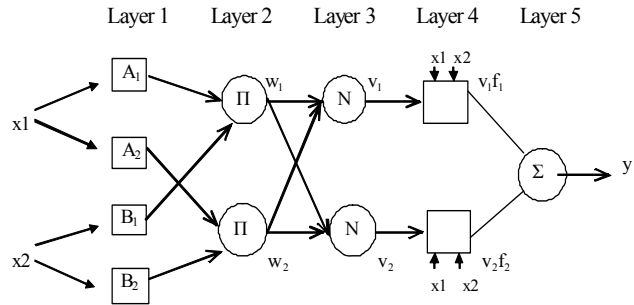

Fig.4. ANFIS Architecture

Each node square or circular applies a function on its input signals and for a given layer nodes have the same type of function. The output  $O_i^k$  of a node  $i$  of the  $k$  layer (called node  $(i, k)$ ) depends on the signals from the layer  $k-1$  and parameters of the node  $(i, k)$ .

$$O_i^k = f(O_1^{k-1} \dots O_{n_{k-1}}^{k-1}, a, b, c, \dots) \quad (1)$$

$n_{k-1}$  is the number of nodes in the  $(k-1)$  layer, and  $a, b, c$  are the parameters of the  $(i,k)$  node.

It should be noted that a circular node has no parameters.

#### Layer 1:

Nodes of this layer are all adaptive nodes. This layer performs fuzzification of the inputs; it determines the membership of each input:

$$O_i^1 = \mu_{A_i}(x) \quad (2)$$

$x$  input of  $i$  node,

$A_i$ : linguistic variable &  $O_i^1$ : degree of membership of  $x$  to  $A_i$ .

The parameters of a node in this layer are those of the corresponding membership function, these are the premise parameters.

#### Layer2:

The nodes of this layer are fixed nodes. They receive the output signals from the previous layer and send their product output

$$w_i = \mu_{A_i}(x_1) \cdot \mu_{B_i}(x_2) \quad i = 1, 2 \quad (3)$$

$w_i$  The degree of truth of the rule  $i$ .

#### Layer 3:

Each neuron in this layer calculates the normalized degree of truth of the fuzzy rule.



$$v_i = \frac{w_i}{w_1 + w_2} \quad (4)$$

The result out of each node represents the contribution of this rule on the final result.

#### Layer 4:

The nodes in this layer are adaptive and perform the consequent of the rules. The output of a node  $i$  is given by:

$$O_i^4 = v_i \cdot f_i = v_i(a_i x_1 + b_i x_2 + c_i) \quad i = 1, 2 \quad (5)$$

The parameters in this layer ( $a_i, b_i, c_i$ ) are to be determined and are referred to as the consequent parameters.

#### Layer 5:

This layer consists of a single neuron circular makes the sum of signals from the previous layer to give the final output of the network:

$$O_1^5 = y = \sum_i v_i \cdot f_i \quad (6)$$

The generalization of the system to a system with multiple inputs does not pose any problem. The number of nodes in the first layer is always equal to the total number of linguistic terms defined.

### 2.2. ANFIS learning's:

There are several learning algorithms for a neuro-fuzzy model [13]. Jang proposed a learning method called "hybrid algorithm". This algorithm combining the least squares method and the gradient descent method is adopted to solve this problem. The hybrid algorithm is composed of a forward pass and a backward pass. The least squares method (forward pass) is used to optimize the consequent parameters with the premise parameters fixed. Once the optimal consequent parameters are found, the backward pass starts immediately. The gradient descent method (backward pass) is used to adjust optimally the premise parameters corresponding to the fuzzy sets in the input domain. The output of the ANFIS is calculated by employing the consequent parameters found in the forward pass. The output error is used to adapt the premise parameters by means of a standard back propagation algorithm. It has been proven that this hybrid algorithm is highly efficient in training the ANFIS [12] [11].

### 3. RESULT AND DISCUSSION

In this work, we classify the cardiac arrhythmias by a neuro-fuzzy approach using ANFIS.

The ECG signals used in this work are recordings collected between 1975 and 1979 by the laboratory of BIH arrhythmia (Beth Israel Hospital) in Boston in the United States, which is known as the MIT-BIH data base [14]. The ECG signals are sampled at a frequency of 360 Hz. Two or more cardiologists have made the diagnosis for these various records and they have annotated each cardiac cycle. These annotations will be useful for learning and assessment of the classification.

The choice of target diseases is dictated by the nature of work itself. Indeed, a review Holter is requested by a cardiologist to detect sporadic events that not appears on the ECG 12 D (12 leads) and especially transient arrhythmias (PVC, PAC).

PVC: The premature ventricular contraction

PAC: The premature atrial contraction

The choice of descriptive parameters which are the input vector is dictated by the nature of the pathology targeted [16] [15].

For describing the heartbeat, we have chosen:

- RRp : the distance between the current R-wave and the previous R-wave (see Figure 8).
- RRs : the distance between the current R-wave and the following R-wave (see Figure 8).
- RRs / RRp : the ratio between the distance RR following the previous one (see Figure 8).
- QRS : the duration of the QRS complex (see Figure 8)

The parameters used were calculated using an algorithm developed and implemented in the LISI laboratory at the University of Rennes 1. This algorithm is based on the technique introduced by Pan J. and Tompkins W.J [17].

The database built is used for learning and testing the classifier. Patients selected to build the database are patients who have diseases targeted (PVC, PAC) and are presented in the following table (Tab.1):



Table.1 Number of beats for each record

records	N	PVC	PAC
100	2225	1	30
116	2175	108	1
200	1726	815	30
201	1325	176	122
209	1850	1	380
210	2100	181	19
223	1986	449	73
233	1029	813	7
234	1700	3	43
<b>Nombre total</b>	<b>16116</b>	<b>2548</b>	<b>705</b>

Given the large number of normal beats compared to other types of beats, and to avoid specialization. We choose 500 beats for each of 3 classes (normal, PAC and PVC) (1500 total to form the learning base).

From this database, we generate an initial fuzzy inference system (FIS) of Sugeno type zero order (see figure.5) with the initial choices includes:

1. Membership function type : "Trapezoidal"
2. Number of membership function for each variable.
  - RRp: 2 functions
  - RRs/RRp: 3 functions
  - QRS: 2 functions
3. Manual initialization of modal points, based on knowledge of the expert (doctor).

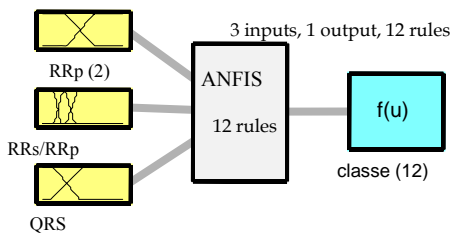

Fig.5. initial neuro-fuzzy model

At the end of the learning, parameters of the initial membership functions (figure.6) will be modified as shown on figure.7.

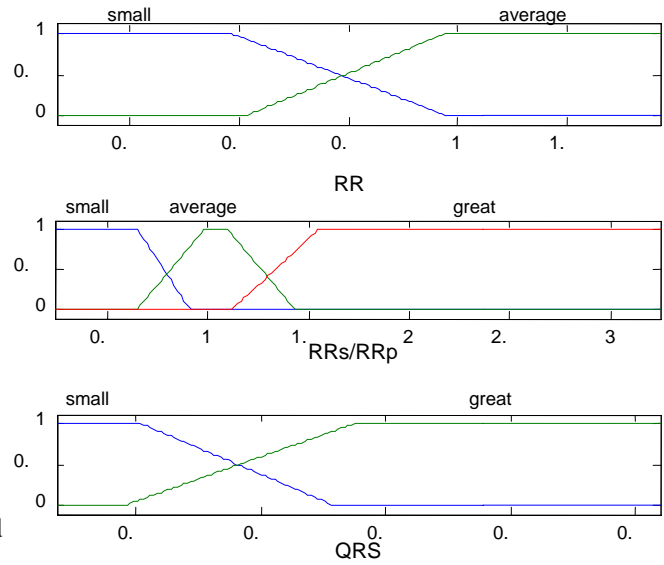

Fig.6. : initial membership functions

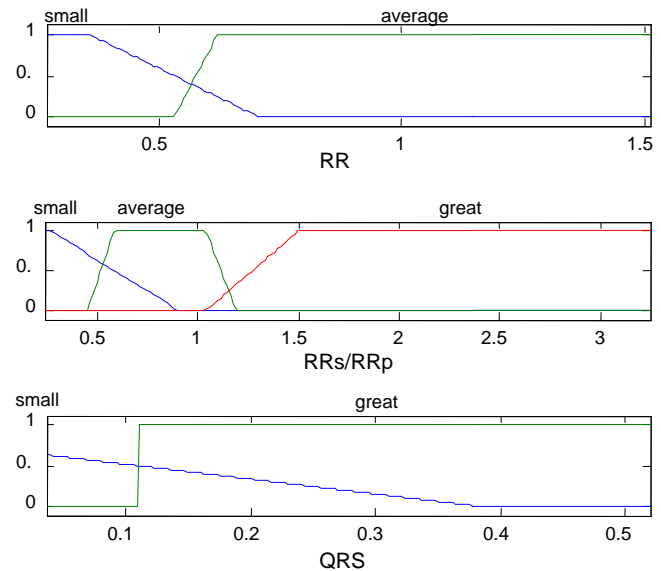

Fig.7: final membership functions (after learning)

#### 4. RESULTS ANALYSIS

The performance of the neural classifiers was evaluated by computing the percentages of sensitivity (SE), specificity (SP) and correct classification (CC), the respective definitions are as follows:

- *Sensitivity (Se %)*:  $[Se = 100 \times TP / (TP + FN)]$  is the fraction of real events that are correctly detected among all real events.
- *Specificity (Sp %)*:  $[Sp = 100 \times TN / (TN + FP)]$  is the fraction of nonevents that has been correctly rejected.



• *Correct classification (CC %):*  
 $[CC=100 \times (TP+TN)/(TN+TP+FN+FP)]$  is the classification rate.

In these formulas TP was the number of true positives, TN was the number of true negatives, FN was the number of false negatives, and FP was the number of false positives.

Since we are interested in estimating the performance of the classifier based on the recognition of PVC beats and PAC beats, the true positives (TP), false positives (FP), true negatives (TN), and false negatives (FN) are defined appropriately as shown below:

- TP: classifies PVC as PVC ( or PAC as PAC)
- FP: classifies normal as PVC or PAC;
- TN: classifies normal as normal;
- FN: classifies PVC or PAC as normal.

Note that

Se1 (%): is the sensitivity for detecting PVC beats.  
 Se2 (%): is the sensitivity for detecting PAC beats.

The results of the evaluation of the neuro-fuzzy classifier in terms of correct classification, sensitivity and specificity are summarized in table 2

Table .2. Performances of the neuro-fuzzy classifier (%).

records	Sp (%)	Se <sub>1</sub> (%)	Se <sub>2</sub> (%)	CC (%)
100	96,15	100,00	95,75	97,30
116	95,26	96,74	100,00	97,33
200	89,36	97,62	93,33	93,44
201	93,25	96,82	95,40	95,16
209	97,23	100,00	95,09	97,44
210	97,01	97,31	96,27	96,86
223	95,11	96,48	97,15	96,25
233	94,59	96,29	90,71	93,86
234	92,75	100,00	93,87	95,54
<b>Average (%)</b>	<b>94,52</b>	<b>97,92</b>	<b>95,29</b>	<b>95,91</b>

The average correct classification is 95.91%. We notice from the results obtained in the table 2 that the neuro-fuzzy classifier NFCL gave satisfactory results (95.91%) and very similar to neural classifier cited in the literature [Chi'05] [Cha'04].

However, the results obtained by our classifier NFCL are explicit and interpretable, which is not the case for neural classifiers (black box type).

Our method generates automatically a knowledge base (12 rules) to justify the classification.

The rule base generated by the NFCL is :

1. If (RRP is small) and (RRS / RRP is small) and (QRS is small) then (class C1)
2. If (RRP is small) and (RRS / RRP is small) and (QRS is great) then (class is C2)
3. If (RRP is small) and (RRS / RRP is average) and (QRS is small) then (class C3)
4. If (RRP is small) and (RRS / RRP is average) and (QRS is great) then (class is C4)
5. If (RRP is small) and (RRS / RRP is high) and (QRS is small) then (class is C5)
6. If (RRP is small) and (RRS / RRP is high) and (QRS is great) then (class is C6)
7. If (RRP is average) and (RRS / RRP is small) and (QRS is small) then (class is C7)
8. If (RRP is average) and (RRS / RRP is small) and (QRS is great) then (class is C8)
9. If (RRP is average) and (RRS / RRP is average) and (QRS is small) then (class is C9)
10. If (RRP is average) and (RRS / RRP is average) and (QRS is great) then (class is C10)
11. If (RRP is average) and (RRS / RRP is high) and (QRS is small) then (class is C11)
12. If (RRP is average) and (RRS / RRP is high) and (QRS is great) then (class is C12)

To clarify our work, we take for example the 260th beat of recording 100

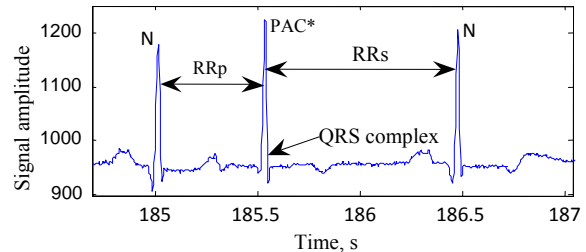

Fig.8 The 260 cycle of record 100, « PAC\* »

Characterizing beat

RRp = 0.53 sec

RRs/RRp = 1.61

QRS = 0.053 sec

RRp: 48.18 % small

23.52 % average

RRs/RRp : 0 % small

0 % average

100 % great

QRS: 50.34 % small  
0 % great

The real output is  $1.99 \approx 2$  (Class PAC).

The rules that contribute to this output are shown in the figure below:

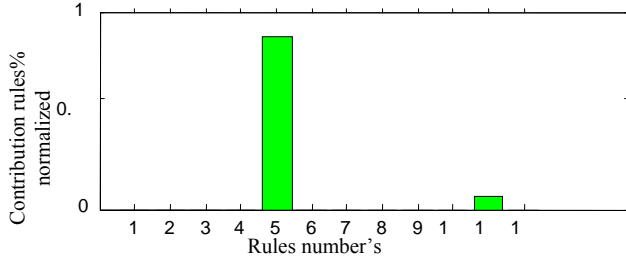

Fig.9. Contribution des règles

**Rule 11** : active 5.83 %

11. If (RRp is average) and (RRs / RRp is great) and (QRS is small) then (class is C11)

**Rule 5** : active 94.17 %

5. If (RRp is small) and (RRs / RRp is great) and (QRS is small) then (class is C5)

With

$$C5 = 1.87$$

$$C11 = 0.12$$

The actual output is the sum of two outputs active:

$$S = C11 + C5 = 1.997 \approx 2 \text{ (class PAC)}$$

The rule "5" has more weight in the final decision, and it is very close to the reasoning of the human expert (cardiologist).

For any beat, we find the most activated rules, which contribute and justify the final decision taken by the neuro-fuzzy classifier NFCL.

## 5. CONCLUSION

This work presents a knowledge extraction and classification of cardiac arrhythmias (PVC, PAC) using a hybrid approach called neuro-fuzzy that combines neural networks with fuzzy logic.

This approach has given very good results with an average correct classification rate of 95.91%, in addition to the justification of decisions taken in the NFCL classifier using its rule base (12 rules). These rules are very consistent and closer to the cardiologist reasoning.

These obtained results are very promising and encourage us to extend this study to other types of cardiac arrhythmias. Such neuro-fuzzy classifier can be easily hardware implemented (real time response) and used in intensive care units.

## REFERENCES

- [1] I. Güler E.D. Übeyli, *Application of adaptive neuro fuzzy inference systeme for detection of electrocardiographic changes in patients with partial epilepsy using feature extraction*. Expert systems with application vol.27 pp.323-330. (2004)
- [2] Sung-Nien Yu, Kuan-To Chou *Integration of independent component analysis and neural networks for ECG beat classification*. Expert Systems with Applications Volume 34 Issue 4 (2007),
- [3] E.D. Übeyli, I. Güler, *Neural network analysis of internal carotid arterial Doppler signals: predictions of stenosis and occlusion*, Expert System with Application vol 25 issue 1 (2003) pp.1-13.
- [4] Zhou J., "Automatic Determining of Premature Ventricular Contraction Using Quantum Neural Networks", Proc. of the 3rd IEEE Symposium on BioInformatics and bioEngineering BIBE'03, pp. 169-173, 10-12 March 2003.
- [5] Nauck, D., Kruse, R., 1999. *Obtaining interpretable fuzzy classification rules from medical data*. Artificial Intelligence in Medicine 16,149-169.
- [6] B.Anuradha *Cardiac Arrhythmia Classification Using Fuzzy Classifiers*. Journal of Theoretical and Applied Information Technology Vol 4, N 4, octobre 2008
- [7] R. Benali M.A. Chikh. *Extraction des connaissances et classification des données médicales* National seminar of informatics in Biskra (Algeria) 2008
- [8] J.J .Buckley and Y. Hayashi, *Neural nets for fuzzy systems*, Fuzzy Sets and Systems, 71(1995) 265-276
- [9] D. Nauck, R. Kruse, *NEFCLASS-A neuro-fuzzy approach for the classification of data*, in: ACM Symposium on Applied Computing, Nashville, New York, February, 1995, pp. 461-465.
- [10] Belal S.Y., A.F.G. Taktak, A.J. Nevill, S.A. Spencer, D. Roden and S. Bevan, *Automatic detection of distorted plethysmogram pulses in neonates and paediatric patients using an adaptive-network-based fuzzyinference system*. Artificial intelligence in medicine. 24, pp.149-165.
- [11] R.J.S. Jang, *ANFIS adaptive-network-based fuzzy inference systems*, IEEE Transactions on Systems, Man, and Cybernetics. vol 23 (3) (1993) pp.665-685.
- [12] Jang JSR, Sun C T and Muzutani E. 2007. *Neuro-Fuzzy and Soft Computing-A*



- computational approach to learning and machine intelligence*. Pearson Education Inc.
- [13] P.Y. Glorennec, *Learning algorithms for neuro-fuzzy networks*, in: A. Kandel and G. Langholz eds., *Fuzzy Control Systems* (CRC Press, New York, 1994) 4-18.
- [14] MIT BIH Arrhythmia Database Directory. Third edition, Harvard MIT Division of Health Sciences and technology, Biomed. Eng. Center. 1992.
- [15] M. A. Chikh, *analyse du signal ECG par les reseaux de neurons et la logique floue : application à la reconnaissance des PVC* doctorat Thesis in Tlemcen University 2005.
- [16] M. A. Chikh, F. Bereksi Reguig, *Application of artificial neural networks to identify the premature ventricular contraction (PVC) beats* Electronic Journal "Technical Acoustics" <http://www.ejta.org>, 2004
- [17] Pan J. et Tompkins W.J. *A real time QRS detection algorithm* IEEE Trans. Biomed. Eng. Vol. 23(4) pp. 230-236, 1985 .

# DELINEATION OF THE COMPLEX QRS AND THE T-END USING WAVELET TRANSFORM AND SURFACE INDICATOR

Dib N., Benali R\*, Hadj Slimane Z & Bereksi-Reguig F

Biomedical Engineering Research Laboratory (GBM)  
Biomedical Electronics Department, science Engineering  
Abou Bekr Belkaid University  
Tlemcen, Algeria  
\*benali\_redouane@yahoo.fr

## ABSTRACT

In this paper, a new algorithm for ECG waves segmentation is described. The algorithm is based on the wavelet transform for the complex QRS delineation and a surface indicator for the detection of the T-end waves.

The described algorithm was evaluated using ECG signals from the universal database MIT BIH. A sensitivity of 99.35% and a positive predictivity of 99.05% are reached. Those obtained results show the good performances of this new algorithm.

**Key words:** ECG delineation, wavelet transform, surface indicator

## 1. INTRODUCTION

The ECG signal is a graphical representation of the heart activity. Indeed, the ECG signal is formed by a succession of waveforms designed P, QRS, T (figure1). Each wave reflects a part of the electrical heart activity. The importance of the ECG signal in the clinical practice is related to the duration and the forms of those waves. In fact, the duration and the forms of ECG waves can be extremely used as clinical indicators marking the presence of cardiac pathologies.

The manual ECG waves delineation seems a difficult and annoying task especially for the analysis of the long recordings as in Holters and ambulatory cases. If a detailed analysis of 12-leads ECG is needed, the manual ECG waves detection is more irritating. In addition, the automatic analysis of the ECG signal seems indispensable due to large number of patients in intensive care units and the need for continuous observation. Consequently, the applicability and appeal of automatic measurements are most evident in the analysis of large data sets. Indeed, automatic ECG delineation makes motivation of recent researches [1-3].

In almost cases, the complex QRS detection is the first step of those algorithms. In fact, the complex QRS is the most significant complex in the ECG signal components.

In reality, this complex is used either to calculate cardiac frequency or the delineation of the others waves as P and T waves. Therefore, many approaches are adopted are to detect the complex QRS. In [4], the high energy of the QRS complex is used to its delineation. Other algorithms are based on the steep slope of the QRS complex [5]. More approaches and principles

such neural network [6], Markov model [7] and morphological transforms are used in the detection algorithms.

The T and P waves can be also used a biomarker of cardiac pathologies. However, few algorithms are devoted to those two waves segmentation [9-10]. In fact, the detection of those waves is very difficult due to their weak amplitudes and their morphology variety.

In this article, a new algorithm is described and discussed. The developed algorithm is dedicated to the complex QRS and t-end localization.

The algorithm is based essentially on wavelet transform for the localization of the complex QRS and a surface indicator for T-end wave delineation.

The algorithm principles will be described in the next section.

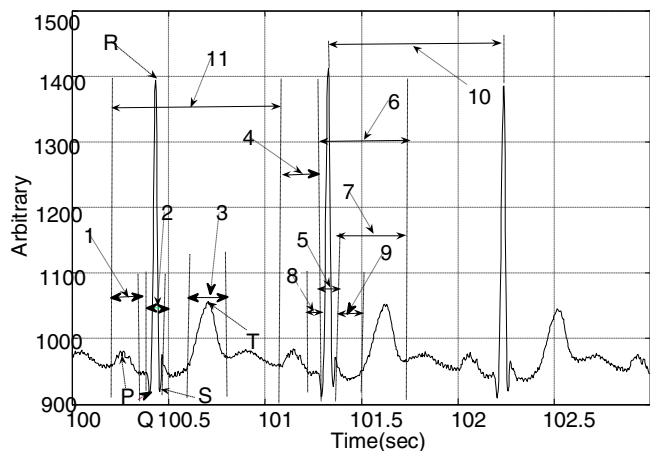
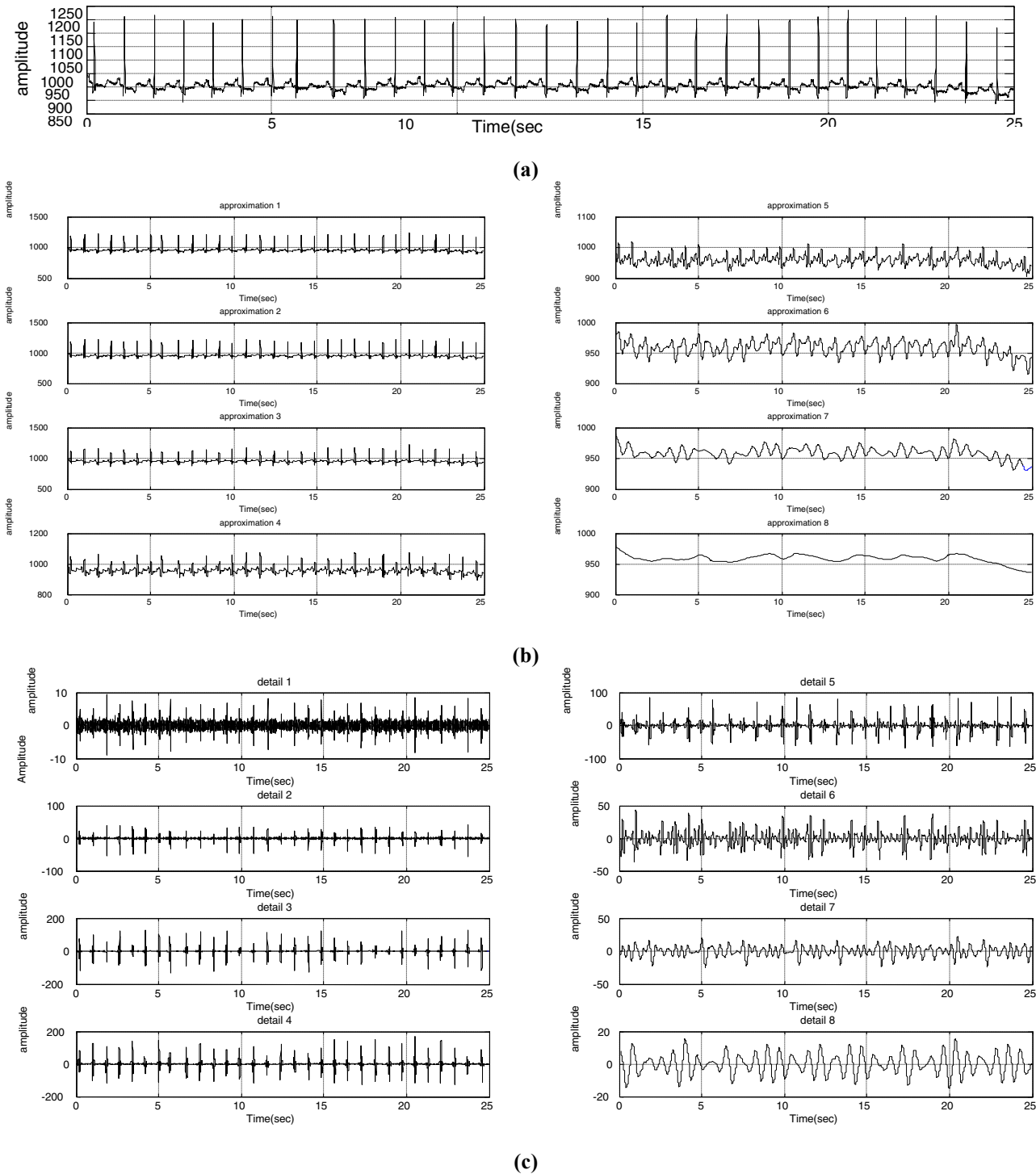

**Figure 1.** Clinical ECG signal features [11].  
(1) P wave; (2) QRS complex; (3) T wave; (4) PR interval; (5) QRS interval; (6) QT interval; (7) ST interval; (8) PR segment; (9) ST segment; (10) R-R interval (or beat); (11) cardiac cycle (including P wave, QRS complex, and T wave).

## 2. MATERIEL AND METHODS

### 2.1. Wavelet transform

Recently, the wavelet transform appears as a very helpful tool in the ECG delineation algorithms [1-3] [12-14].



**Figure 2.** ECG signal decomposition: (a) ECG signal, (b) approximations, (c) details

Mathematically, the wavelet transform consist to explore signal by a special function called “mother wavelet”. The two operations dilatation/contraction and translation will be applied on the mother wavelet to generate a set of functions called “wavelets family”. This issue functions have a same form as the mother wavelet but they differ in their frequency band length.

$$\psi_{a,b}(t) = \frac{1}{\sqrt{a}} \cdot \Psi\left(\frac{t-b}{a}\right)$$

The projection of the signal on the wavelets family generates a number of coefficients defined by:

$$C(a,b) = \frac{1}{\sqrt{a}} \cdot \int_{-\infty}^{+\infty} x(t) \cdot \Psi^*\left(\frac{t-b}{a}\right) dt$$

Those coefficients describe the correlation between signal and the wavelet family.

When, the scale parameters  $a$  and the translation parameters  $b$  are continue, the wavelet transform is intended to be continue and it is called “continue wavelet transform”. On contrary, when the original signal must be reconstructed from the coefficients, a discretization of

Those two parameters must be done. The wavelet is called the discrete wavelets transform.

In fact, each signal is formed by low frequencies called “approximations” and high frequencies named “details”.

The wavelet transform allows a separation of details and approximations using a pair of quadratic filters. The approximation issue from the decomposition at level (n-1) will be applied to the pair of filters to give, in its turn, approximation and detail. The decomposition the level n will be applied to the approximation. Indeed, the pair of filters will only applied on the approximations.

Figure 2 illustrates the ECG signal decomposition using discrete wavelet transform.

## 2.2. Algorithm description

The proposed algorithm is constituted by two parts. The first step is dedicated to the complex QRS detection while the second part is devoted to the T-end localization. Figure 3 represents the diagram of the developed algorithm.

### 2.2.1 R peaks detection

First, the decomposition of the ECG signal to eight levels is done using the DB4 mother wavelet. The choice of the mother wavelet is related to the fact that there is great correlation between Db4 and QRS complex. Generally, The QRS complexes are concentrated at the fourth details D3, D4, D5 and D6. Those details are added together to obtain a filtered ECG signal where the complexes QRS are properly seen. Then, the obtained signal is squared. This operation permits to amplify the QRS peak. The amplified signal is compared again an adaptive threshold and consequently the R peaks are detected.

### 2.2.2 the Q wave detection

The Q wave localization is done using the derivative method. The derivative method is based on a differentiator filter. When it is applied to the ECG signal, this method permits to calculate the steep slope of the electrocardiogram signal. In the proposed algorithm, steep slopes are calculated using “Chan and Khan” formula [14].

$$slope = -2 \cdot x_{i-2} - x_{i-1} + x_{i+1} + 2 \cdot x_{i+2}$$

The Q wave is detected when two successive slopes exceed an adaptive threshold.

### 2.2.3 S wave localization

The S wave is detected as the minimum of the ECG signal after the R peak within a fixed window. The length of the window is determined experimentally.

### 2.2.4 T-end delineation

The algorithm proposes two steps to the T-end delineation. The first step consists of QRS complexes elimination. In the second step, the T-end is detected using the same principles described by Zhang et al in [15]. This principle consists to calculate an indicator related to the surface covered by the T wave and delimited in a special manner. The surface indicator is calculated using integration which is accomplished by a sliding window w.

$$A(t) = \int_{t-w}^t [ecg(\tau) - ecg(t)] d\tau$$

Zhang et al demonstrated that the surface indicator takes its maximum when the time t coincides with the T-end. Indeed, looking for T-end is done by searching the instant t maximizes the surface indicator A (figure 4).

## 3 RESULT AND DISCUSSION

The universal MIT- BIH database is used to evaluate the proposed algorithm. The used database contains 48 records with 30 minutes duration for each record [16]. The two parameters; sensitivity (Se) and the positive predictivity (P+); are calculated to evaluate the performances of the developed algorithm [17]. The obtained results are compared with those obtained by [1], [18] and [19].

The results comparison is illustrated in table 1.

	Total beats number	Sensitivity Se (%)	Positive predictability +P (%)
Wavelet methods [18]	5100	99.18	98.00
P-spectrum methods [19]	-----	94.32	97.66
Developed algorithm	5100	99.35	99.05

**Table1.** Algorithm evaluation results

The average sensitivity Se and the average positive predictivity P+ are 99.18% and 99.05 %, respectively. As the table 2 shows, those results are better than the results obtained by [18] and [19]. In fact, the use of the wavelet transform permits either the good separation of the ECG waves from the noises or the separation of the different ECG components. Besides, the elimination of the QRS complexes facilitates the localization of the T-end wave. In M Vitek et al algorithm [1], the wavelet transform is also adopted to detect the QRS complex. Their algorithm is evaluated using CSE database. The M. Vitek et al algorithm is 99.13% for Franks leads. Consequently, our algorithm sensitively is greater than their algorithm. In addition, the surface indicator is simple to implement and its shows good performances when it is applied to detect the T-end instants.

## 4 CONCLUSION

The described algorithm shows good performances. In fact, the wavelet transform is used to detect the QRS complexes whereas the surface indicator is applied to delineate the T-end wave. When using wavelet transform, the noise and QRS complexes are separated. This allows good localization of those complexes. Surface indicator seems simple to implement and gives good results.



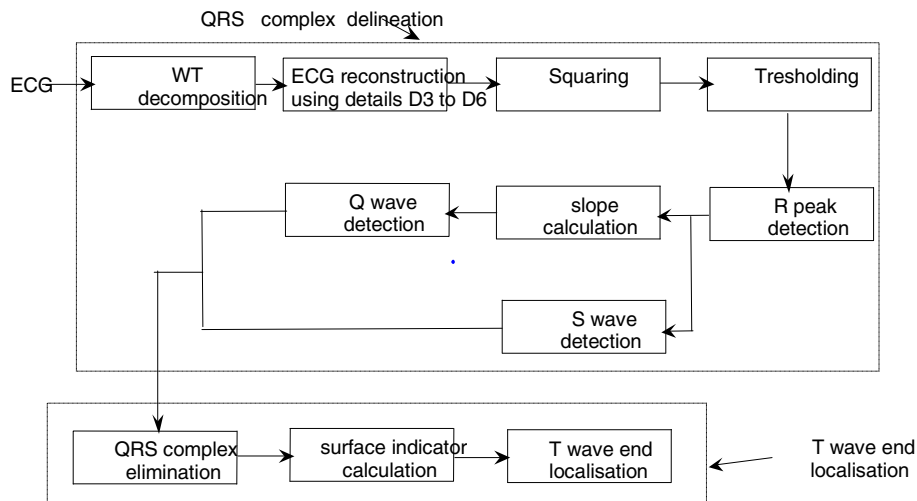

Figure 3. Algorithm Description

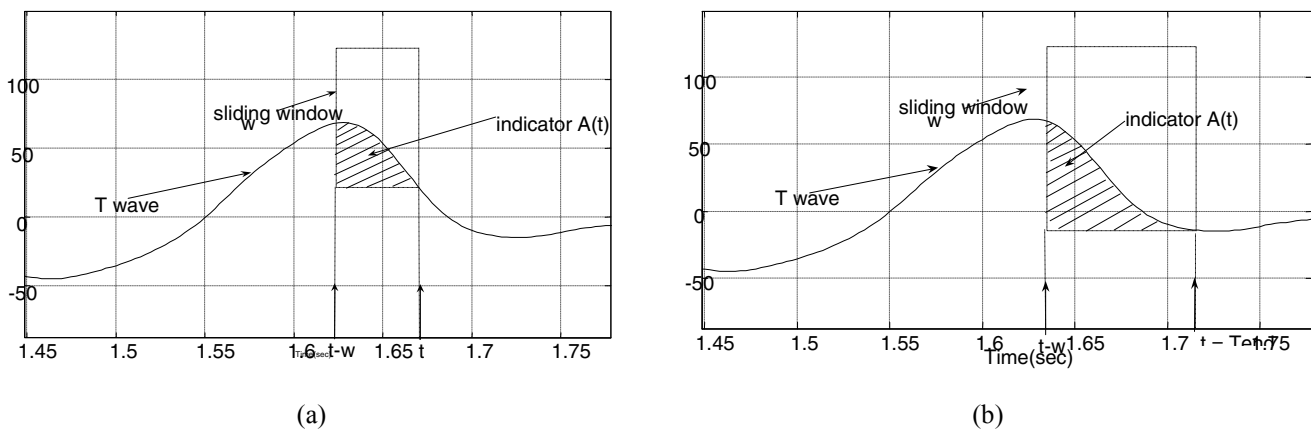

Figure 4. T-end localization principle

## REFERENCES

- Vitek M, Hrubec J, Kozumplik J, "A Wavelet-Based ECG Delineation in Multilead ECG Signals: Evaluation on the CSE Database", *IFMBE Proceedings*, vol. 25, pp. 177–180, 2009.
- Ghaffari A, Homaeinezhad M, Khazraee M, Daevaeiha M, "Segmentation of Holter ECG Waves Via Analysis of a Discrete Wavelet-Derived Multiple Skewness-Kurtosis Based Metric", *Annals of Biomedical Engineering*, DOI: 10.1007/s00415-007-3001-6, 2010.
- Ghaffari A, Homaeinezhad M, Akraminia M, Atarod M, Daevaeiha M, "A robust wavelet-based multi-lead electrocardiogram delineation algorithm", *Medical Engineering and Physics*, vol. 31, pp. 1219–1227, 2009.
- Pan J, Tompkins WJ, "A real-time QRS detection algorithm", *IEEE Transaction on Biomedical Engineering BME*, vol. 32, pp 230–136, 1986.
- Holsinger W, Kempner K, Miller M, "A QRS preprocessor based on digital differentiation", *IEEE Trans. Biomed. Eng.* vol. 18, pp. 121–217, 1971.
- Osowski S, Hoai L, "ECG beat recognition using fuzzy hybrid neural network", *IEEE Transactions on Biomedical Engineering*, vol. 48, pp. 1265–1271, 2001.
- De Lannoy G, Frenay B, Verleysen M, Delbeke J, "Supervised ECG delineation using the wavelet transform and hidden Markov models", *IEEE Proc. IFMBE*, vol. 22, pp. 22–25, 2008.
- Sun Y, Chan K, Krishnan S, "Characteristic wave detection in ECG signal using morphological transform", *BMC Cardiovascular Disorders*, 2005.
- Joeng H, Kim K, Hwang S, Lee M, "A new Algorithm for P-Wave detection in the ECG Signal", *Proceedings of the Annual International Conference of the IEEE Engineering in Medicine and Biology Society*, vol. 1, pp. 42–43, 1989.
- Burak A, "New Approaches to T-wave Analysis from Surface ECG", *Cardiac Electro-physiology Review*, vol. 3, pp. 319–323, 1999.
- Yun-Chi Y, Wen-Yune W, "A QRS complexes detection for ECG signal: The difference operation method", *computer method and programs in biomedicine*, vol. 91, pp. 245–254, 2008.
- Castro K, Geva A, "ECG feature extraction using optimal mother wavelet", *IEEE EMBE Int. Conf*, pp. 346–350, 2000.
- Li C, Zheng C, Tai C, "Detection of ECG characteristic points using wavelet transforms", *IEEE Trans. Biomed. Eng.*, vol. 42, pp. 21–28, 1995.
- Chan K, So H, "Development of QRS method for real-time ambulatory cardiac monitor", *Proc 19 Annu Int Conf IEEE EMBS, Chicago, USA*, pp. 289–292, 1997.
- Qinghua Z, Alfredo Illanes M, Claire M, Yves P, Michel S, "An algorithm for robust and efficient location of T-wave ends in electrocardiogram", *irisa Publication in-terme 1744, 2005*, available at: [www.irisa.fr](http://www.irisa.fr).
- Moody G, Mark R, EMIT-BIH Arrhythmia Database Directory, Harvard MIT Division of Health Sciences and Technology, *Biomedical Engineering Center*, 1997.
- ANSI/AAMI EC57, "Testing and reporting performance results of cardiac rhythm and ST segment measurement algorithms", *AAMI Recommended Practice/American National Standard*, 1998. Available at: <http://www.aami.org>;
- Dinh H, Kumer D, Pah N, Burton B, "wavelets for QRS detection", *the 23rd annual EMBS international conference*, Istanbul, TURKEY, October 25–28, 2001.
- Peng Qiu G, Ray Lui K, "A robust method for QRS detection based on modified P- spectrum", *Acoustics, Speech and Signal Processing, ICASSP 2008, IEEE International Conference*, pp. 501–504, 2008.