

Study of Polarization Mode Dispersion in the Optical Digital Connection to High Bit Rate

Mokhdar Amel¹, Chikh-bled Mohammed²

¹Department of Telecommunications , Technology Faculty , BP 119 university Abou bekr Belkaid, Tlemcen 13000 Algeria

¹ amelmokhdar@yahoo.fr

²Department of Telecommunications , Technology Faculty , BP 119 university Abou bekr Belkaid Tlemcen 13000 Algeria

² mek_chikhbled@yahoo.fr

Abstract

Polarization Mode Dispersion (PMD) is a factor which limits the bit rate of the optical transmissions. The PMD is such an effect which is time broadening due to the dependence of the group velocity to the signal polarization. The deformation effects of the impulses become considerable from 40 Gb/s. This paper, we reviews the degrade PMD effect in the telecommunications optical connections to high bit rate, due to the evolution of quality factor (Q) according to the fiber length, bit rate and PMD coefficient , well as the impact PMD on the degree of polarization and electrical power, we discuss also the representation of the polarization state and PMD vector on the Poincaré sphere.

Keywords: Polarization mode dispersion, bit rate, Poincaré sphere

1. INTRODUCTION

Polarization Mode Dispersion (PMD) is a physical phenomenon in optical fiber that causes light pulses to spread in time. If the amount of spread (dispersion) is excessive, adjacent light pulses will overlap and interfere with each other. This interference will manifest itself as an increased Bit Error Rate as the receiver may be unable to discern adjacent bits from each other. As the bit spacing decreases, as in high data-rate transmissions such as 10 Gbps or 40 Gbps [1], excessive PMD will severely impact network operation. Its can cause serious problems in high bit-rate transmissions [2]. PMD is a property of a single-mode fiber or an optical component in which signal energy at a given wavelength is resolved into two orthogonal polarization modes with different propagation velocities [3]. The work presented in this paper focuses on the study of the PMD effects in optical fibers standards .

2. POLARIZATION MODE DISPERSION

The PMD is shown on two phenomena [4]:

- The birefringence, which is the difference between the phase velocities associated with the two orthogonal modes of polarization. It results from the geometrical asymmetry of the index profile and the residual stress profile. It is the origin of the difference between group velocities of the two modes of polarization and linked to

the temperature [5]. Several works have been discussed in the birefringence and refractive index as a function of temperature [6]

- **Mode Coupling.** The birefringence of a single-mode fiber varies randomly along its length owing to the variation in the drawing and cabling process [3]. As mentioned earlier, modeling of birefringence with the length of fiber gets complicated because of mode coupling. To understand the concept of mode coupling (see figure 01), consider a light pulse that is plane polarized in the fast - axis injected into the fiber. As the pulse propagates across the fiber, some of the energy will couple into the orthogonal slow-axis polarization state, this in turn will also couple back into the original state until eventually, for a sufficiently long distance, both states are equally populated [4].

It was possible to manipulate all-optical manner and simultaneously the Polarization state of light as well as its intensity profile and in that a single optical fiber .This system combines in a single segment of a fiber and a polarization attractor intensity regenerating type Mamyshev [7-8].

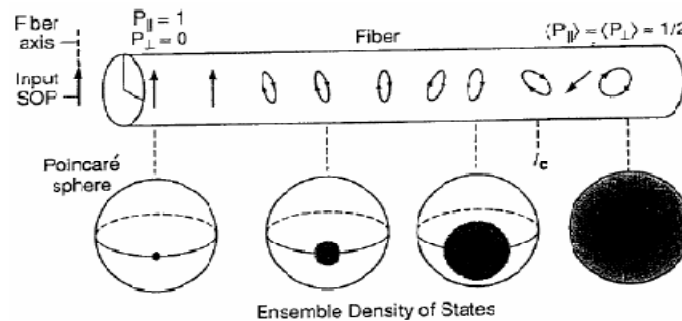

Fig 01: Coupling length

The fiber length at which the ensemble average power in one orthogonal polarization mode is within of the power in the starting mode is called the *coupling length* or *correlation length* L_c . It is a statistical parameter that varies with wavelength, position along the fiber length and temperature. Typical values of coupling length range from tens of meters to almost a kilometer [9].

When we send a signal on a single mode fiber, without being concerned with its polarization, the two modes are excited at the same time. Each one has its own of propagation velocity. This shift of time group propagation causes the unfolding of the signal at the output fiber, and thus a jamming of information (Figure 02). [9]



Fig 02. The PMD effect on an impulse

Polarization Mode Dispersion (PMD) is the average Differential Group Delay (DGD) one expects to see when measuring an optical fiber. DGD is the time separation or delay between the two principal polarization modes of the transmission link at the receiver. DGD is an instantaneous event and varies randomly with wavelength and time. This means that DGD is a statistical parameter, obeys the laws of probability theory and thus has uncertainty associated with it. PMD is the average value of a distribution of a large number of independent DGD measurements

The DGD (Differential Group Delay), is given by the following relation ("equation 1") [10].

$$DGD = \beta_i * \sqrt{L_c} * \sqrt{L} \quad (1)$$

Where β_i is linear birefringence, L_c and L are respectively the coupling length and the connection length. This shift until our days was often neglected because there remains tiny. However this value, called the DGD grows with the length of fibers. Progress in the telecommunications today a lengthening of the distances from propagation of the optical signal (with the arrival of the optical amplifiers). Thus, this shift between the components increases and the critical value of the DGD on the connection performances decreases with the increase of the bit rate.

The rise in bit rate in transmission systems using optical fibers has revealed phenomena that were previously negligible.

This is the case of PMD, including some fibers of older generations already installed: the phenomenon was not taken into account into the 90s. Also many installed fibers have important PMD values.

Many examples of measurement are given in the literature. In general, the results show a tolerance of about 10% of the bit time for NRZ and 15% of the bit time for RZ formats. Considering that this phenomenon becomes troublesome from 10% of the bit time, a PMD of 10 ps (resp. 2.5 ps) is the tolerable limit for a 10 Gbit / s (resp. 40 Gbit / s). [11].

3. SIMULATION

All simulations presented below are made to study the impact PMD on the optical transmission connection quality we discuss also the polarization phenomenon and PMD verses electrical power..This using the simulator optisystem

3.1 Simulation Presentation

The system showed in Figure 2 is utilized in the simulations.

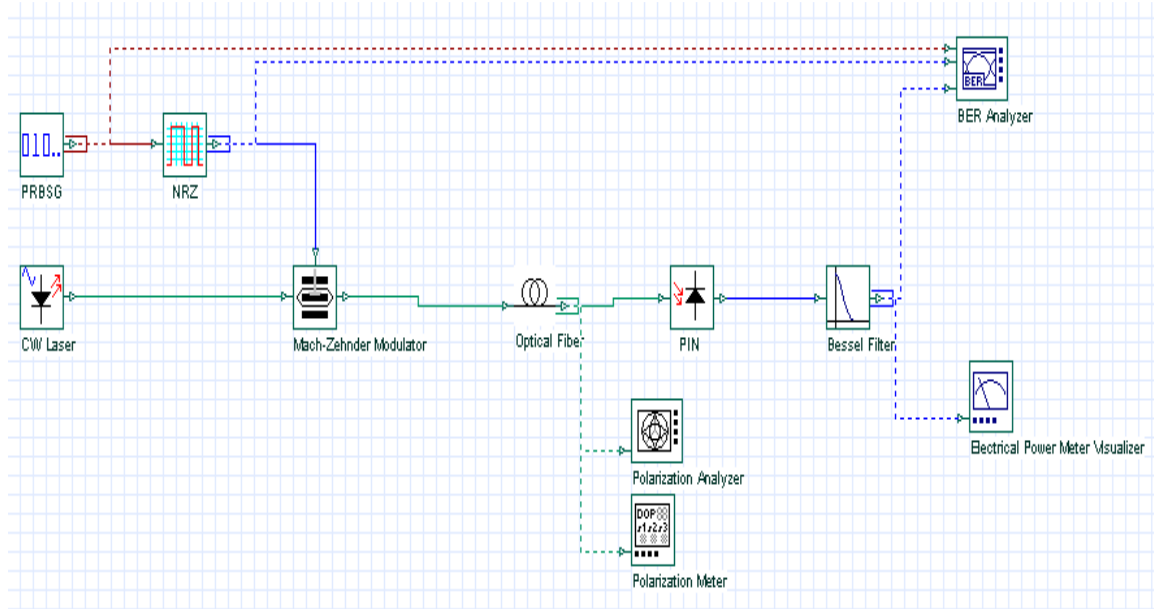

Fig 03. Simulation of optical connection taking into account the PMD

This chain (figure 03) is consisted of the following elements (from the left to the right):

- a generator a Pseudo Random Binary Sequence (PRBS) of the bit rate D ,
- a generator a Non Return to Zero (NRZ) coded signal,
- a generator a continuous wave (CW) optical signal with 1550 nm
- a simulates a Mach-Zehnder modulator using an analytical model ,
- an optical fiber with length (L) = 100 km and PMD coefficient = $0.5 \text{ ps/km}^{1/2}$,
- a polarization analyzer allows the user to calculate and display different properties of the signal polarization , including the Poincaré Sphere ,
- a polarization meter allows the user to calculate the average polarization state of the optical signal, including the degree of polarization (DOP) ,
- to show the PMD effect on the transmitted signal , it is necessary to add a photodiode PIN to convert the optical signal into electric signal of bandwidth 50 GHz, sensitivity = 0,55 A/W and dark current = 5nA,
- The output of the photodiode PIN a low-pass filter defined approximate Bessel of order 5, and cutoff frequency of 0.8 times the bit rate,
- Electrical power meter allows the user to calculate and display the average power of electrical signals,
- The signal is finally characterized by the analysis of Bit Error Rate (BER) and Eye Diagram.

3.2. Simulation results

3.2.1. Simulation the PMD in the connection

The Simulation is used for the following parameters:

- Length fiber (L) = 100 km
- Bit rate (D) =40 Gbit /s
- PMD coefficient (PMD) = $0.5 \text{ ps/km}^{1/2}$
- Chromatic Dispersion (CD) =neglected

The Figure 04 represents the eye diagrams obtained in the output of reception filter according to the PMD is taking into account or not.

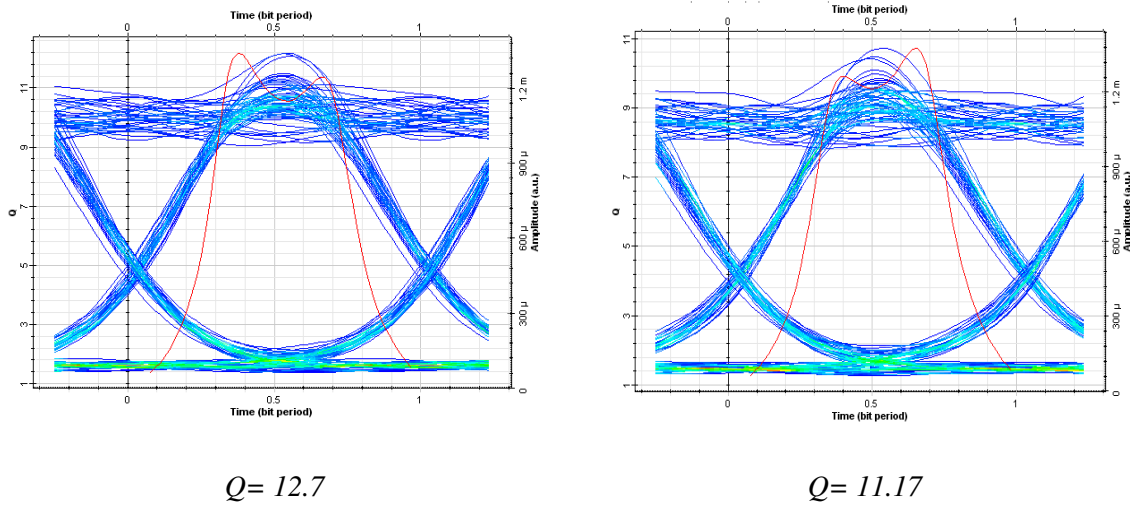

Fig 04. The eye Diagrams in the output of the reception filter (a) without taking into account the PMD, (b) with taking into account the PMD in fibers

The quality factors were calculated in two cases, and the PMD diminish its value of 10% for 100 km of transmission. Its impact wasn't extremely important but we may suppose that for the most important lengths fibers, and consequently to the higher values of the DGD even closer to time bit of data, its role will be result on the transmission quality.

3.2.2 PMD impact on the quality factor according to length fiber

The Simulation is used for the following parameters:

- Length fiber = variable
- Bit rate = 40 Gbit/s
- Chromatic Dispersion = neglected
- PMD coefficient = $0.5 \text{ ps/km}^{1/2}$

The results of this simulation are shown on the Figure 05.

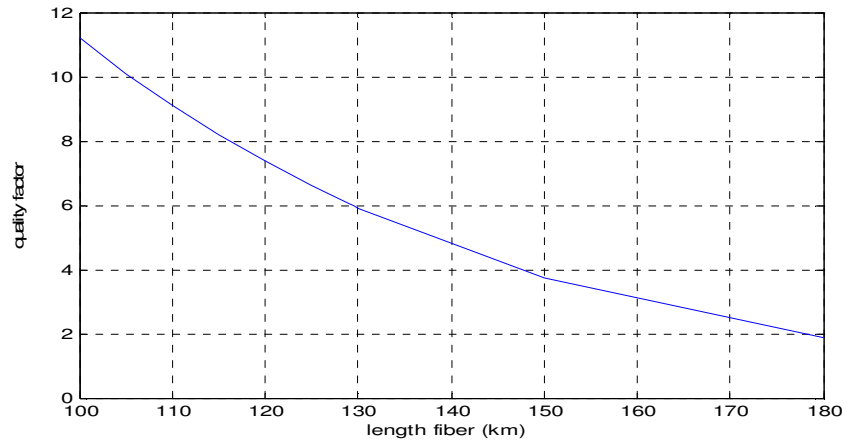

Fig 05. The impact of the length fiber on quality factor (Q)

According to Fig 05, we notice the more the length of the connection increases the factor of quality decreases. For a bit rate of 40Gbit/s, the lengths of connections cannot exceed the 129 km so that the system has a good quality. It means that the length of fiber influences on the PMD. When the length of transmission fiber increases the DGD also increases (see equation 01)

3.2.3. PMD impact on the quality factor according to bit rate

The Simulation is used for the following parameters:

Bit rate (D) =variable

Length of the fiber (L) =129 km

Chromatic Dispersion (CD) =neglected

PMD coefficient (PMD) = $0.5 \text{ ps}/\text{km}^{1/2}$

The results of this simulation are shown on the Fig 06.

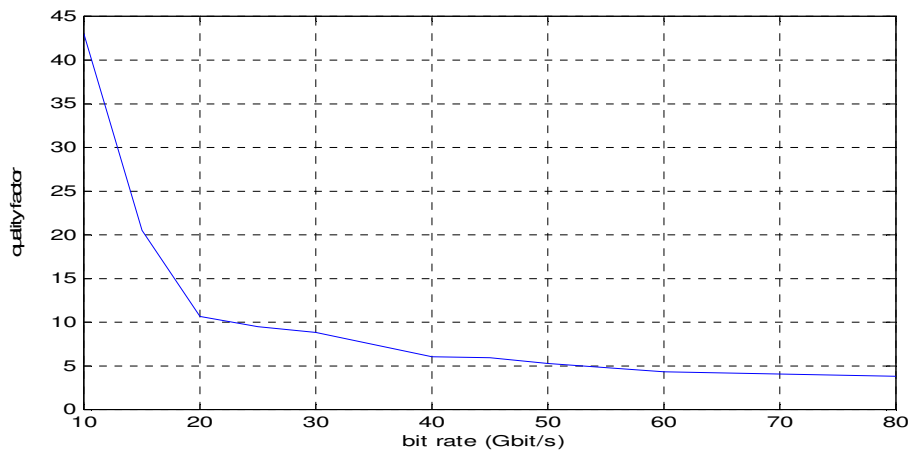

Fig 06. The impact of the bit rate on quality factor (Q)

According to the figure 06, we see that there is decrease in the quality factor (Q) when increasing the bit rate. We also notice that for a flow rate of 40 Gbit/s a quality factor Q = 6.10 is obtained, but beyond this value of the bit rate the quality factor degrades, this means that the flow rate is a factor that limits the performance of a connection transmission fiber optical.

3.2.4 PMD impact on the quality factor according to PMD coefficient

The Simulation is used for the following parameters:

- Bit rate =40 Gbit/s
- Length of the fiber =129 km
- Chromatic Dispersion =neglected
- PMD coefficient =0.5 ps/km^{1/2}

The results of this simulation are shown on the Fig 07.

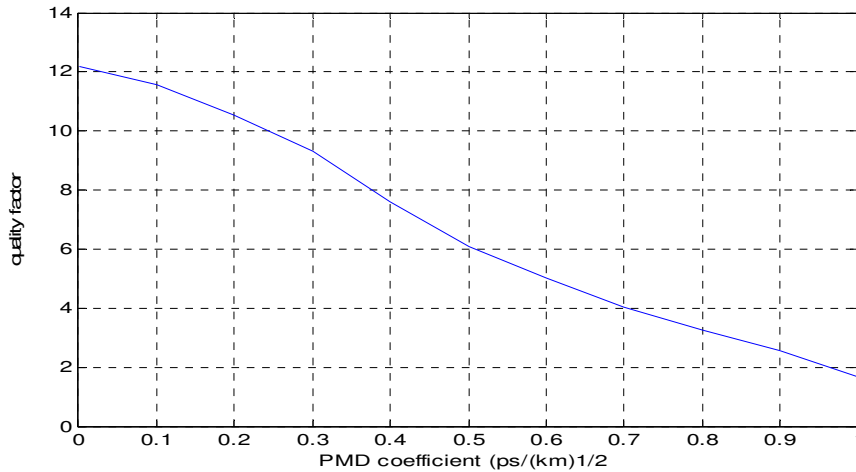

Fig 07. The impact of the PMD coefficient on quality factor (Q)

According to Figure 07, only the PMD coefficient values $\leq 0.5 \text{ ps/km}^{1/2}$ gives the quality factor (Q) ≥ 6 .

The other PMD coefficient values, that is to say (PMD $> 0.5 \text{ ps/km}^{1/2}$) degrade the quality factor. It means that the PMD coefficient impacts the PMD.

When the coefficient PMD increases the delay group differential also increases.

3.2.5. Polarization State

The PMD is related to the vectorial character of the light (more commonly indicated by the term of polarization).

The Figure 08 represents the polarization state on the Poincare sphere .

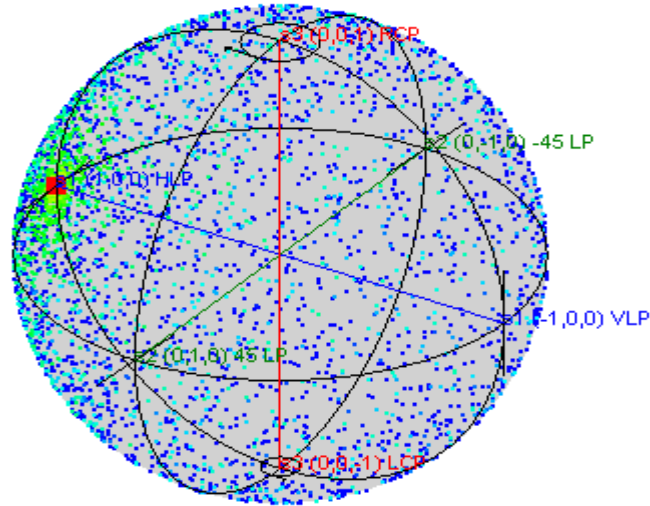

Fig 08 : Poincaré sphere

According to figure 08, we notice that at the output fiber the signal received has a polarization state elliptical (azimuth (α) = 0.01098° and ellipticity (ϵ) = 0.00454°). The total power of the polarized light is S_0 about -13.6863 dBm and remains lower compared to the input laser diode power and worth -0.194229dBm. The energy part will turn on the slow polarization axis, and will exchange energy with the original state polarization. These proper modes vary randomly along the fiber length L to which strong mode coupling counteracts enlargement of signals propagating in the fiber.

The polarization state is located on the northern hemisphere of the Poincaré sphere and the degree of polarization DOP is about 99,851%.

3.2.6. Degree of Polarisation

The value of this estimator does not depend only on the energy distribution between the two PSP (Principal State of Polarization), but also the PMD coefficient ie the DGD.

The Figure 08 represents the value of DOP according to the PMD coefficient for the output of the line:

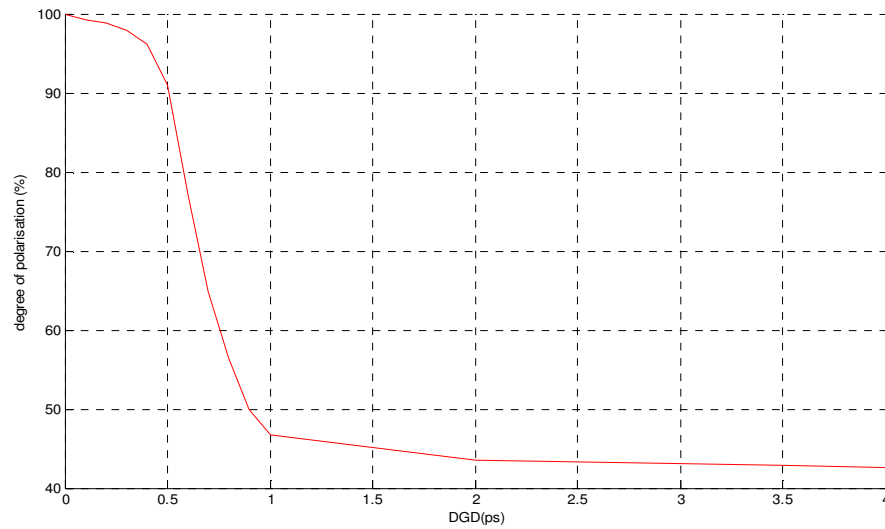

Fig 09. Variation of degree of polarization according to PMD coefficient

According to figure 09, we notice that the degree of polarization of the transmission fiber decreases as the PMD coefficient increases. Indeed, the PMD distributes the signal energy in two orthogonal polarizations between two much more separated in times the PMD coefficient is large pulses. It is not possible to separate the two parameters.

The degree of polarization is also sensitive to degradation of optical signal to noise ratio (OSNR), but is relatively insensitive to other transmission effects such as chromatic dispersion and SPM (Self Phase Modulation)

3.2.7. PMD impact on Poincare Sphere

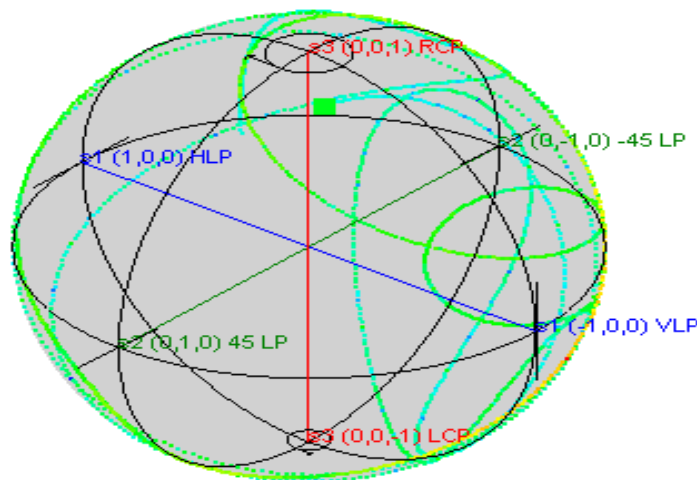

Fig10. PMD Second order

According to figure 10, we notice that the direction of the rotation axis and the rotation angle changing with frequency. And the output polarization state performs a rotations series on the Poincaré sphere. PMD second order is the most frequent phenomenon in the long distance regime.

3.2.8 Electrical power and PMD

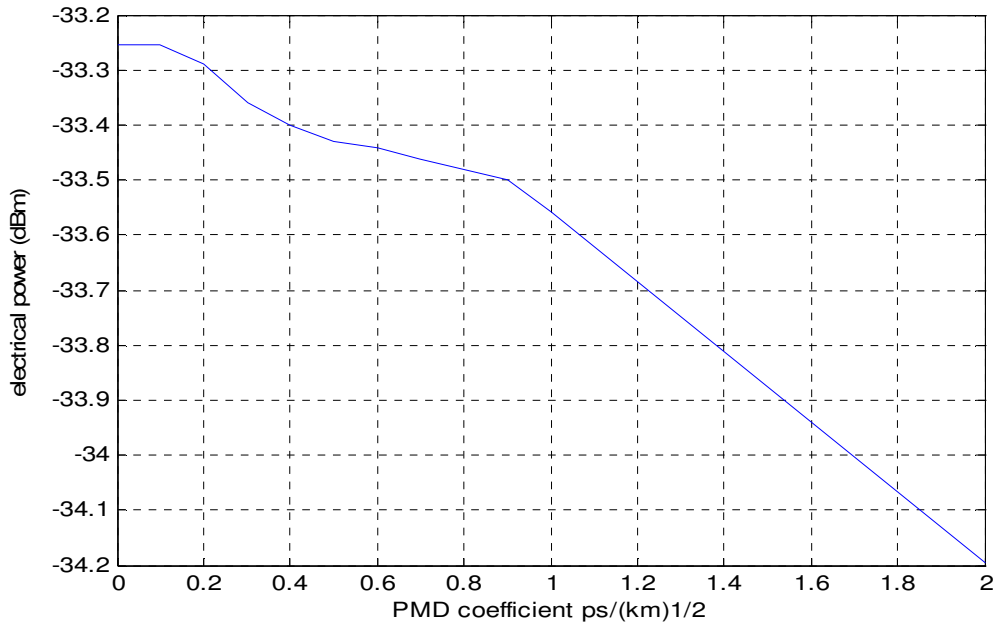

Fig 11. Variation of the electrical power according to PMD coefficient

According to figure 11, we notice that as the PMD coefficient increases the electrical power decreases, and also the quality factor decreases accordingly the Bit Error Rate BER increases, this is due to the effect of the dispersion on the Polarization Mode Dispersion. A linear effect of the dispersion compensates the nonlinear effects of the PMD of the fiber.

4. CONCLUSION

Simulation results show that for optical links to 100 km quality factor may decrease more than 10%.

To maintain a good transmission quality of an optical signal, the maximum bit rate must be 40 Gbit/s, the distance from fiber should not exceed the 129 km and the values of PMD coefficient $\leq 0.5 \text{ ps/km}^{1/2}$.

The Polarization Mode Dispersion is a considerable parameter in the transmissions by optical fiber and should be integrated.

The random variation of the polarization states generates a random variation of the polarization characteristics; the latter is represented on the Poincare sphere.

REFERENCES

- [1] Ling-Wei Guo, Ying-Wu Zhou, Zu-Jie Fang, "Pulse broadening in optical fiber with PMD", *Optics communication*, pp. 83-87, 2003.
- [2] N. Gisin, J. P. Von Der Weid, J. P. Pelloux, "Polarization Mode Dispersion of short and long single mode fibers " *IEEE Journal of Lightwave Technology*, Vol. 9, No. 7, Jul. 1991, pp. 821-827.
- [3] H. Sunnerud, " Polarization mode dispersion in optical fibers : characterization, transmission impairments and compensation ", PhD Thesis, Mar. 2001
- [4] C.D. Poole, and J. Nagel, "Polarization effect s in lightwave systems," in *Optical Fiber Telecommunications*, Eds. I.P. Kaminov, and T.L. Koch, San Diego: Academic Press, vol. III A, 1997.
- [5] D. Gupta, A. Kumar, K. Thyagarajan, *Polarization mode dispersion in single mode optical fibers due to core-ellipticity*, *Optics communications*, 263 (2006) 36-41.
- [6] N. Boudrioua, A. Boudrioua, F. Monteiro, E. Losson, A. Dandache et R. Kremer, *Polarization mode dispersion fluctuations in single mode fibres due to temperature and its effect in high speed optical communication systems*, soumis à *Optics Communications* (2007).
- [7] J. Fatome, S. Pitois, P. Morin, and G. Millot, "Observation of light-by-light polarization control and stabilization in optical fibre for telecommunication applications," *Opt. Express* 18, 15311-15317 (2010).
- [8] P. V. Mamyshev, "All-optical data regeneration based on self-phase modulation effect," in *European Conference on Optical Communication, ECOC'98*, 475-476, Madrid, Spain (1998).
- [9] F. Kapron, A. Dori, J. P eters, and H. Knehr, "Polarization - mode dispersion: should you be concerned?" *NFOEC'96*, Denver, pp. 757-768, 1996.
- [10] Bruyere Frank, "Impact of First -and Second- Order PMD in Optical Digital Transmission Systems ", *Optical Fiber Technology*, 1996, Vol.2, pp. 269-280.
- [11] B. Clouet "Étude de la dispersion modale de polarisation dans les systèmes régénérés optiquement "; Thèse doctorat UNIVERSITÉ DE RENNES I, décembre 2007, pp. 62-64